

TECHNOLOGICAL UNIVERSITY OF DELFT  
Laboratory of Chemical Technology

IN-SITU HYPOCHLORITE PRODUCTION

by

W. Klut

Supervisors:

Prof. ir. W.A. de Jong

Drs. H.G. Merkus

LIBRARY  
INTERNATIONAL REFERENCE CENTRE  
FOR COMMUNITY WATER SUPPLY AND  
SANITATION (IRC)

**irc**

international reference centre  
for community water supply  
and sanitation

who collaborating centre

**cir**

centre international de référence  
pour l'approvisionnement  
en eau collective et l'assainissement

centre collaborant de l'OMS

245.2-841N-8321

## Acknowledgement

This report covering literature up to 1977 was prepared to serve an inter-university collaborative programme of the Technical Universities of Delft and Bandung. The International Reference Centre for Community Water Supply and Sanitation introduced the study of On-site Hypochlorite Generation in above programme as relevant and with potential application for developing countries. In agreement with the Faculty the IRC disseminates the report in a project to promote the technology and to contribute to national plans to bring more safe water in the countries. An update of the state-of-the-art will be part of the IRC project on "Local Manufacture of Disinfectants".

T.K. Tjiok, IRC

## CONTENTS

	page
1.0 Introduction.	1
2.0 Disinfection of (drinking) water with chlorine or hypochlorite	3
2.1 Basic chemistry	3
2.2 Disinfection	7
2.3 Chlorine dosage for disinfection	9
3.0 Methods for chlorinating drinking water	10
3.1 Chlorine	10
3.2 Solid calcium hypochlorite	11
3.3 Bleaching powder	12
3.4 Sodium hypochlorite solution	12
4.0 Chlorine and hypochlorite production on an industrial scale	13
4.1 Electrolysis of sodium chloride with a diaphragm cell	14
4.2 Electrolysis of sodium chloride with a liquid mercury cathode	14
4.3 Electrolysis of a hydrochloric-acid solution	15
4.4 The salt process	16
4.5 The Deacon process	16
4.6 Various oxidation processes	16
4.7 Process selection of the in-situ chlorine/hypochlorite production	17
5.0 Aspects of the electrolysis of NaCl	18
5.1 Chemical reactions with NaCl electrolysis	19
5.2 Anodes in the NaCl electrolysis	20
5.3 Cathodes	26
5.4 The diaphragm cell	27
6.0 Equipment for the in-situ production of hypochlorite	31
6.1 Electrolysis of the total supply of drinking water	32
6.2 Hypochlorite dosage to the supply of drinking water	35
7.0 Conclusions	54
8.0 Bibliography	56

INTERNATIONAL JOURNAL OF WATER SUPPLY  
No. 10, 1989 AD The Hague  
Tel. (070) 314911 ext. 141/142

ISSN: 8321  
CODEN: 254-2 841N

## SUMMARY

On account of problems of drinking water disinfection in Indonesia the possibility of using "in-situ" hypochlorite generators instead of the usual dosing of liquid chlorine has been considered.

It is clear that such generators are not only important for Indonesia, but for other developing countries as well.

This report deals with the possibilities that exist in this field concerning equipment and the conditions under which it can be applied.

It appears that the simple membraneless hypochlorite cells are most suitable for general application in developing countries.

## 1.0 Introduction:

Some subjects concerning basic chemicals for the supply of drinking water are discussed in a report by Ir. T.K.Tjiook dated 6-10-77 on deliberations with Prof.Ir.J.P.W.Houtman, Prof. Ir.W.A. de Jong and Drs. H.G. Merkus in the framework of the JTA-9a project.

JTA 9a is a cooperation project of the department of Chem. Technology of the Institut Teknologi Bandung and the Technological Universities of Twente and Delft.

One of the subjects concerns the local production of chlorine or hypochlorite on a small scale for the disinfection of drinking water.

The need for such a local production system arose because the supply of these disinfecting chemicals ran up against difficulties through lack of foreign currency and adequate transport. The importance of proper disinfection of drinking water in countries such as Indonesia needs no further argument. In the report the possibility of electrolysis of common salt is put forward.

In the last few years a considerable development has taken place in the field of "in-situ" preparation of chlorine and hypochlorite. This was more or less occasioned by objections that were raised against the storage of liquid chlorine by drinking water companies.

Hypochlorite as a substitute for chlorine is very attractive, but high transportation costs impeded extensive application. As a result of the development of modern hypochlorite generators the possibility of producing the hypochlorite at the water works themselves has been created. Modern cells such as the Cloromat of Ionics can even compete with liquid chlorine dosage.

The "in-situ" preparation of hypochlorite by means of electrolysis is in principle extremely suitable for application in developing countries.

The selection of the type of cell or process will in this case not be determined merely by economical factors.

Qualities with respect to simplicity during operation and in construction will certainly be as important.

Availability of chloride and electricity supply will also play a role in the final selection.

This report is in the first place meant to gain an insight into the available equipment and its patent situation.

In order to be able to evaluate the equipment thoroughly, the industrial chlorine production methods, in particular the diaphragm process, are discussed. The problems that occur here are largely the same as those of the on-site production.

At the same time knowledge of these processes is of substantial importance in order to pick up ideas for alternative chlorine production.

The purpose of chlorination is the eventual disinfection of drinking water. In order to somewhat familiarize oneself with the terminology and the problems of disinfection of drinking water, a summary of the basic principles of water chlorination has been given in the following chapters.

Furthermore a summary will be given of the various chemicals that can be used for chlorination.

## 2.0 Disinfection of (drinking) water with chlorine or hypochlorite:

### 2.1 Basic chemistry. ref. (1) and (2).

In view of the aim of this report it seems useful to give an outline of the basic chemistry of chlorinating water. When gaseous chlorine is added to water the following equilibrium results:

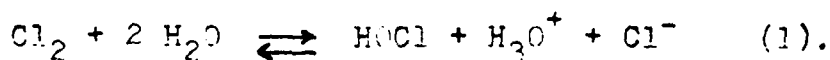

This equilibrium is momentary; the equilibrium constant is:

$$K^{25^\circ\text{C}} = \frac{\text{H}_3\text{O}^+ \text{Cl}^- \text{HOCl}}{\text{Cl}_2} = 4.5 \times 10^{-4}. \quad \text{ref. (1)}.$$

With concentrations under 1000 ppm and a pH greater than 3 the equilibrium is entirely on the hypochlorite side. With sufficiently high pH hypochlorous acid (HClO) dissociates,  $K^{25^\circ\text{C}} = 3.7 \times 10^{-8}$  ref. (1). Above pH = 8.5 hypochlorous acid is fully dissociated.

The above is illustrated in fig.1, in which the fractions of the possible components are shown.

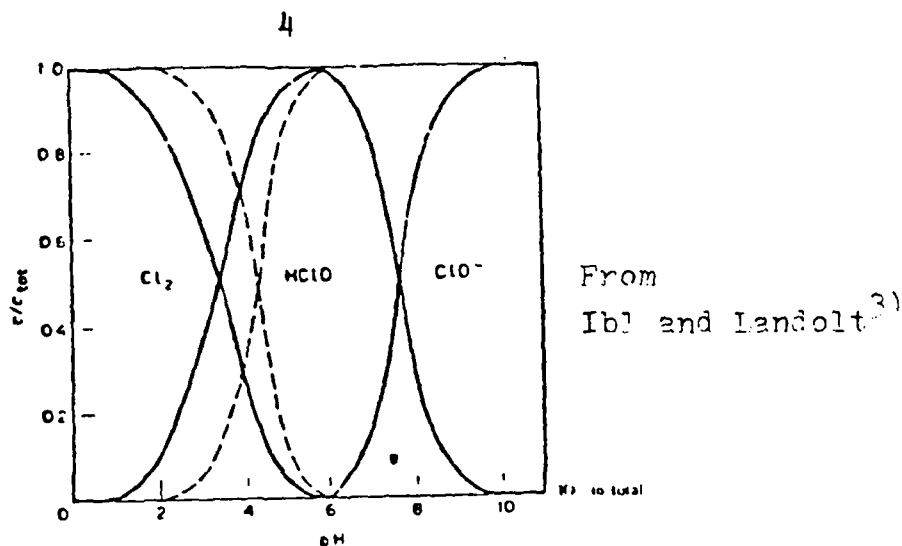

Fig. 1 Influence of pH on ratio of concentration  $c$  of  $\text{Cl}_2$ ,  $\text{HClO}$  and  $\text{ClO}^-$  to total concentration ( $c_{\text{tot}} = c_{\text{Cl}_2} + c_{\text{HClO}} + c_{\text{ClO}^-}$ ).  
Calculated from (1) and (2) for  $7^\circ\text{C}$ . ———, in  $\text{H}_2\text{O}$  ( $\text{Cl}_2 = \text{HClO} + \text{ClO}^-$ ); - - - -  
in  $4 \text{ M NaCl}$  ( $\text{Cl}^- \gg \text{HClO} + \text{ClO}^-$ ).

It is clear that chlorination by gaseous chlorine does not differ essentially from chlorination by hypochlorite. As a result of the above equilibriums the oxidizing activity is a matter of pH. An example of this is the bleaching of paper pulp, one of the oldest and most important applications of chlorine. Two bleaching methods apply here,

- the acid method, pH = 2
- the alkaline method, pH = 9.

In the first case the equilibrium (1) is on the  $\text{Cl}_2$  side and chlorination of the pulp mainly occurs, involving some destructive oxidation. When the pH increases the oxidizing degradation of the pulp together with the forming of  $\text{HOCl}$  assumes serious proportions. Above a pH of 9 the  $\text{OCl}^-$  ion mainly occurs, which causes maximum oxidation with minimum degradation.

The potential bleaching activity or oxidizing capacity of the various bleaches is expressed with the term "available chlorine", derived from the terminology of the former iodometric determination, whereby the bleaching activity was given in an equivalent amount of chlorine.

This terminology can cause confusion however, e.g.  $\text{NaOCl}$  contains 47.7 (weight)% chlorine, while the amount of available chlorine is 95.4 %.

In watertechnology the term "free available chlorine" is used, referring to the concentration of hypochlorite ( $\text{ClO}^- + \text{HClO}$ ).

The most important and complex chemistry of the chlorination of water is the reaction of chlorine with the various forms of nitrogen which can occur in water. The reaction with nitrogen in fact determines the amount of the "residual free available chlorine", which is available for the disinfecting effect.

In general nitrogen occurs in two main groups:

- Inorganic nitrogen  $\text{NH}_3$ ,  $\text{NO}_3^-$ ,  $\text{NO}_2^-$
- Organic nitrogen in the form of amino acids and proteins.



The reaction with ammonia is most important so far as inorganic nitrogen is concerned. In a dilute aqueous solution (1 to 50 ppm) three different chloroamines can be formed.

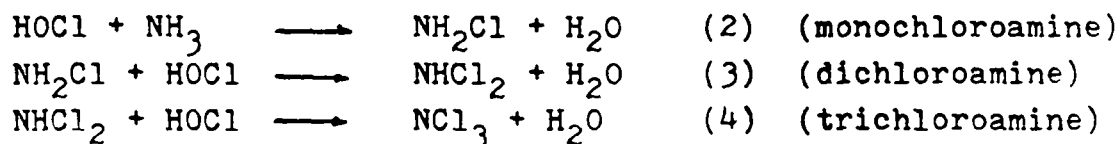

With an excess of ammonia and a pH of 7 to 8 all free chlorine is converted to monochloroamine.

The reaction rate is extremely important and depends on the pH, which is illustrated in the following table:

pH	t(99% conv.) in sec.	
2	421	
4	147	temperature: 25°C
8.3	0.069	fivefold excess of ammonia. $\text{NH}_3=10^{-3}$
12	33.2	

With a sufficient excess of hypochlorite and suitable pH dichloroamine and trichloroamine can be formed; the reaction rates are generally lower.

The reaction equations (3) and (4) are important for the so-called "breakpoint" phenomenon.

With increasing chlorine dosage the residual chlorine concentration turned out to decrease considerably above a certain dosage. See fig 2.

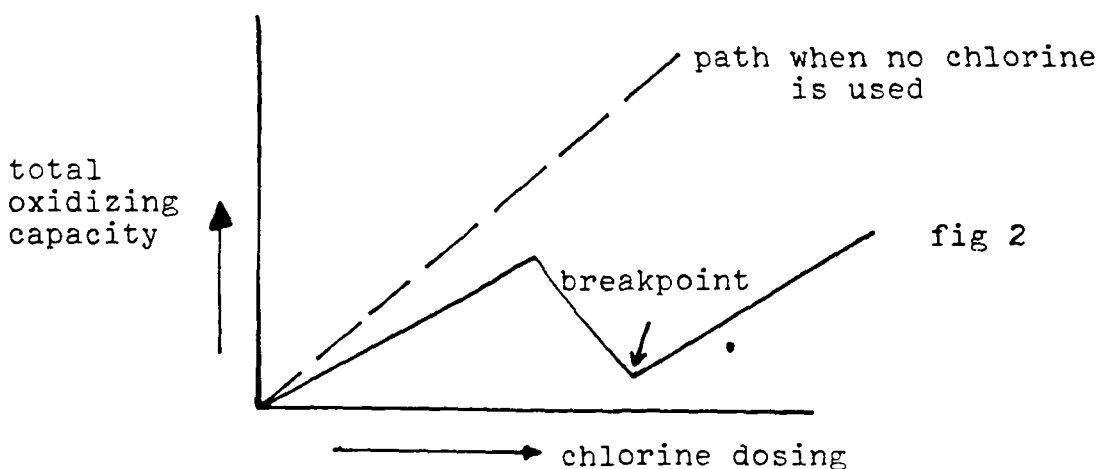

Furthermore it appeared that from this breakpoint smell and taste of the water disappeared and that the disinfecting effect of the chlorine increased substantially.

Fig. 3 illustrates the path of the various chlorine products as a function of the chlorine dosage in the case of there being only ammonia nitrogen.

fig. 3  
From White<sup>1)</sup>

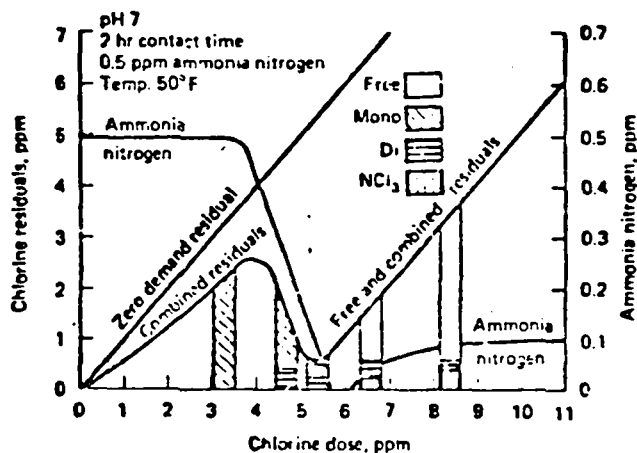

It is clear that the increased disinfecting effect should be attributed to free hypochlorite.

When the ratio chlorine/nitrogen (molar) reaches two, two important reactions occur that will change the concentrations of monochloroamine and dichloroamine:

- according to reaction (3) dichloroamine is formed from monochloroamine.
- breakdown of dichloroamine according to

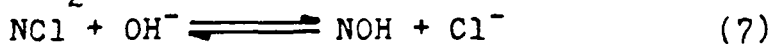
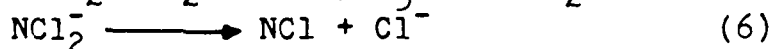
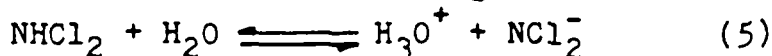

There are three possibilities for further breakdown:

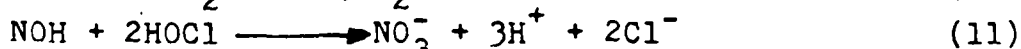
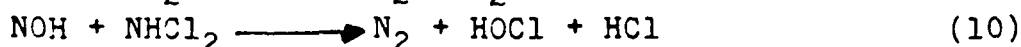
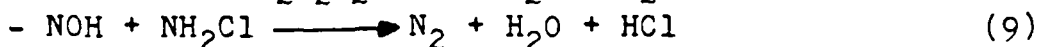
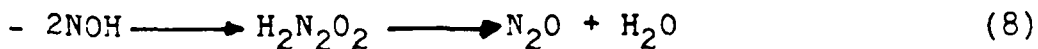

The result is therefore a total reduction in the quantity of chloroamines in the water, explaining the "breakpoint" phenomenon.

The presence of organic nitrogen causes great problems when producing acceptable drinking water. The main difference with ammonia is the reaction rate; ammonia is eliminated within an hour of contact time, while proteins may still be present even after a few days.

The breakdown of these compounds occurs through a number of complex organic amines, which is expressed in the breakpoint chlorination. In this case, no actual breakpoint occurs, but a so-called "plateau effect". See fig. 4.

fig. 4  
from White<sup>1)</sup>

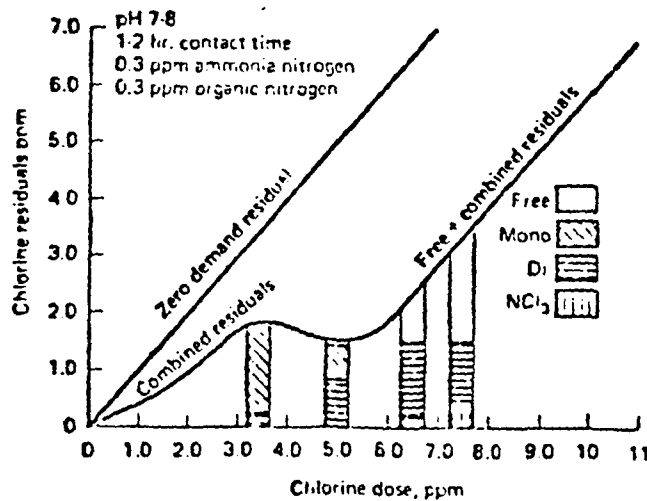

Furthermore it turns out that the concentration of the chloroamines does not decrease with an increase in chlorine dosage. A considerable amount of NCl<sub>3</sub> is even produced, which accounts for the unfavourable properties of this type of water. The concentration of the chloroamines is not constant, because the free chlorine continues to react. If the period in the water purification plant is not sufficiently long, an obnoxious smell will continue to develop in the distribution network for days.

## 2.2 Disinfection.<sup>1,2)</sup>

The mechanism that is responsible for the disinfecting action of the residual chlorine compounds is not entirely clear.

Nowadays it is assumed that the enzymatic system of a cell is affected and that the equilibrium in the cell is disturbed. The metabolism increases so rapidly that it soon results in the death of the cell.

Apart from the mechanism, the efficiency of the various disinfectants is regarded as a function of the diffusion through the cell membrane.

Factors that influence the efficiency are:

- type of disinfectant
- concentration
- contact time
- temperature
- type and concentration of the organism
- pH.

An outline of the disinfecting properties of the various residual chlorine compounds (residuals) will now follow.

- Hypochlorous acid ( $\text{HClO}$ )

Hypochlorous acid is the most effective compound of the residual chlorine compounds; a consequence of the easy diffusion through the cell membranes. This relatively high diffusion rate is caused by the electric neutrality and the small size of the molecule.

Because of the electric charge the hypochlorite ion cannot permeate the cell membrane properly and as a consequence it is much less effective (it may differ by a factor of 80 to 300).

This implies that the disinfecting effect of hypochlorous acid is a function of the pH.

The sum of the concentrations of  $\text{HOCl}$  and  $\text{OCl}^-$  is known as "free Chlorine".

- Monochloroamine ( $\text{NH}_2\text{Cl}$ ).

The effectiveness of monochloroamine is at least a factor of 20-25 smaller than that of hypochlorous acid.

Causes mentioned<sup>1)</sup>: - lower oxidation potential

- reversible reaction with enzymes
- the effect of monochloroamine lies in the hydrolysis causing  $\text{HOCl}$ .
- low diffusion rate through the cell membrane.

The required contact time is a factor of 80-100 larger than that for free chlorine.

If the available contact time in the drinking water plant for the removal of organic nitrogen is not sufficiently long, ammonia is wantonly added to suppress the concentration of the troublesome dichloroamine.

- Dichloroamine ( $\text{NHCl}_2$ ).

Dichloroamine is a stronger disinfectant than monochloroamine. In the water-handling technology this substance, however, is avoided as much as possible as a consequence of the problems of smell and taste.

- Nitrogen trichloride ( $\text{NCl}_3$ )

Nitrogen trichloride is a strong oxidizer, which has been used for more than 25 years for the bleaching of flour, as an insecticide and as a pesticide for fungi. No research as yet has been carried out as to the disinfecting action in water, but it is generally assumed that  $\text{NCl}_3$  contributes to the destruction of micro organisms.

- The remaining organic chloramines hardly have any disinfecting properties or none at all.

### 2.3 Chlorine dosage for disinfection.

The resistance of the various pathogenes against the free chlorine varies.

Several researchers have studied the contact times required to kill bacteria, spores and amoebae.

Fig. 5 gives an outline of the results.

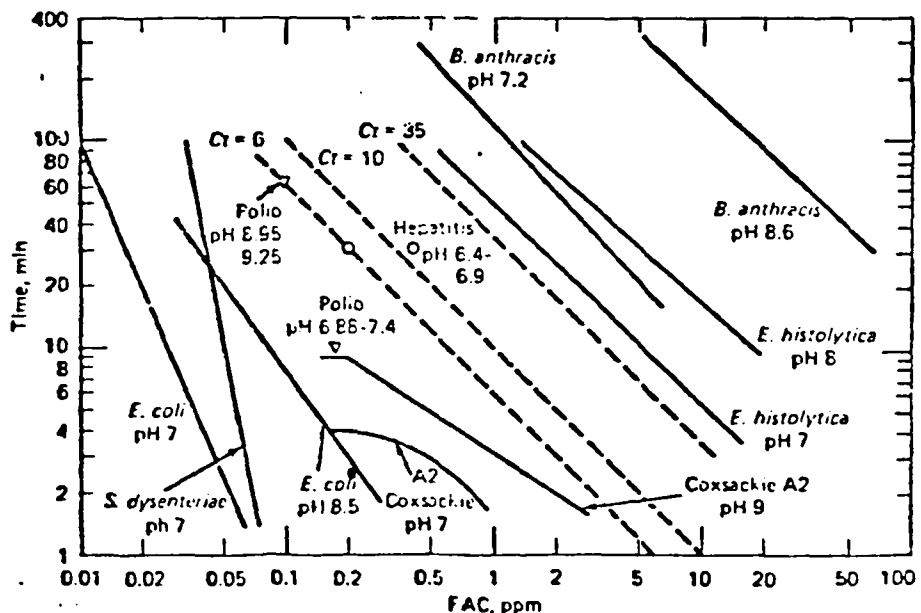

Fig. 5  
From White<sup>1)</sup>

Fig. 5 Disinfection versus free available chlorine residuals. (Time scale is for 99.6 to 100 percent kill. Temperature was in the range of 20 to 29°C, with pH as indicated.) Reprinted from Journal American Water Works Association 54 (11), Nov. 1962, by permission of the Association.

It turns out that the relations between contact time and dosage can be expressed in the following equation:

$$y = ax^b, \text{ or } \log y = b \log x + \log a.$$

On double logarithmic paper  $b$  is the direction coefficient. In most cases it is  $-1$ , so that the relation changes to:

$$t = a C^{-1} \quad \text{or} \quad a = Ct$$

in which  $t$ : contact time for 99.6% disinfection.

$C$ : concentration of free chlorine.

$a$ : constant for a certain organism.

Nowadays the virus Coxsackie A2 is chosen as the destructive parameter for optimal chlorine dosage. This virus has been chosen because up till now no viruses have been discovered that are more resistant. There remain the spores of the anthrax bacterium and the cysts of *E. histolytica*.

Practically speaking the spores cannot be destroyed with chlorine; it is better to remove the cysts by filtration.

The above relation applies to free chlorine; this means that for nitrogenous water the actual chlorine dosage must be higher. Starting point for water with inorganic nitrogen is that the chlorine dosage should be such that the total residual chlorine concentration should be made up of free chlorine ( $\text{HOCl} + \text{OCl}^-$ ) for about 85 to 90%.

In the case of water with organic nitrogen the matter becomes more complicated. A rule of thumb that usually yields the best results is a chlorine dosage that produces a total residual chlorine concentration of 6 ppm., with approximately 5 ppm. free chlorine, 0.4 ppm. monochloroamine and 0.6 ppm. dichloroamine. In order to obtain relatively as much monochloroamine as possible extra ammonia is added.

### 3.0 Methods to chlorinate (drinking) water:<sup>1,5)</sup>

An enumeration of the chlorine-containing chemicals that are used for the chlorination of water is given below.

#### 3.1 Chlorine.

The chlorine dosage takes place from cylinders with a capacity of

about 1 ton of liquid chlorine. In principle the apparatus consists of an evaporator and an injection system for gaseous chlorine. See fig. 6.

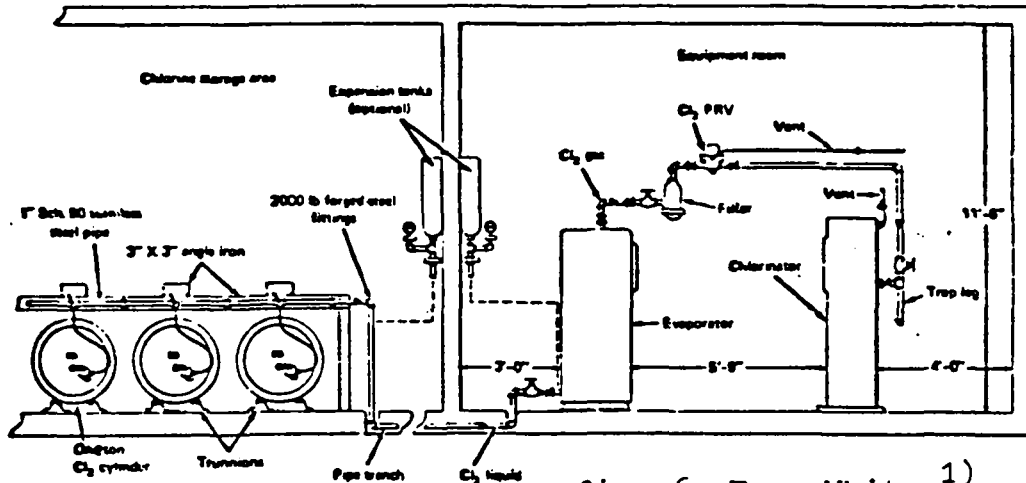

fig. 6. From White 1)

Such a system is applied in the large drinking water companies. It requires a relatively large investment (safety precautions, storage, dosing system).

A well-run provision line is important, because storage of liquid chlorine is subject to restriction.

It is clear that in developing countries these conditions can hardly be met.

### 3.2 Solid calcium hypochlorite. $\text{Ca}(\text{OCl})_2$ .

Trade marks: HTH, Perchloron, Pittchlor.

Calcium hypochlorite is the normal choice if supply has to take place from overseas and if storage is necessary.

It can be obtained as a powder or as tablets and it is fairly stable. It contains 70% available chlorine.

When storing, heat and contact with lightly inflammable substances should be avoided: moisture from the atmosphere induces decomposition. At the place of use the calcium hypochlorite is dissolved and dosed as a fluid. When using hard water clogging of the dosing apparatus as a result of the forming of carbonate should be taken into account.

As a result of the rather complicated method of preparation, there is no production of this substance in the developing countries, so that calcium hypochlorite must be obtained through import with all the disadvantages involved.

Direct preparation of a calcium hypochlorite solution is somewhat

easier and can be effected by dissolving chlorine in milk of lime (35% available chlorine).

Production should take place near the drinking water company and is only worthwhile if the required chlorine is obtained in another way than through electrolysis of sodium chloride (see Chap. 4) and if direct chlorine dosing is not technically feasible.

### 3.3 Bleaching powder, (CaOCl<sub>2</sub>),

If bleaching powder is dissolved in water hypochlorite and chloride are formed,

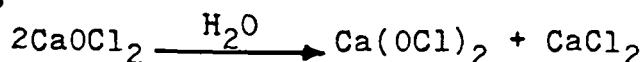

Dissolving is usually problematic due to cake formation.

Preparation is rather simple; under atmospheric pressure chlorine gas reacts with solid Ca(OH)<sub>2</sub>. There are relatively many bleaching powder factories in the developing countries.

Application for chlorinating purposes takes place here in the form of

- dosing of a bleaching-water solution
- use in the so-called "chlorination pots", whereby a porous earthenware jar filled with bleaching powder is brought into contact with e.g. springwater.

### 3.4 Sodium hypochlorite solution (NaOCl).

Sodium hypochlorite solution is used to a great extent,

this in spite of the higher transportation costs and the larger storage space in comparison with calcium hypochlorite. For the NaOCl solution is better manageable and does not cause difficulties in pumping and dosing.

It is produced by dissolving chlorine in a solution of sodium hydroxide,



This production occurs centrally on a large scale, after which distribution takes place to the small-scale consumers.

The product is corrosive, however, difficult to ship and is not stable during storage (except in low concentrations). The solution normally has a content of 17% NaOCl and is guaranteed at 14%.

In warm periods, however, it is not uncommon that the content drops to values below 10%. Higher concentrations than 17% produce an even more unstable product and cause problems with the crystallization of NaCl.



The advantages with dosage are too considerable, however, to change to calcium hypochlorite.

In developing countries sodium hypochlorite solutions are available in plastic cans; because of the reasons described the quality is not stable.

Of the abovementioned chemicals only bleaching powder seems to be produced in developing countries. The basis for the processes used is wastegas from the electrolysis of NaCl; to a minor extent sodium hypochlorite is available in some countries.

Another process is discussed in chapter 4.

An important development in the technology of chlorinating drinking water is the production of sodium hypochlorite at the drinking water company itself.

These hypochlorite generators offer the developing countries opportunities to solve the problems of the disinfection of drinking water

Needed are: - Common salt (NaCl), normally speaking essential to food supply, so that distribution lines are available.  
- Electricity, which will probably have to be generated on the spot with alternative energy sources, such as solar energy, water power and wind energy. A simple woodstoked gas engine is also a possibility.

#### 4.0 Chlorine and hypochlorite production on an industrial scale:

In the foregoing it has been shown that the "in-situ" preparation of hypochlorite could be a solution for the problems regarding the disinfection of drinking water in developing countries. There are in principle two possibilities for producing hypochlorite through electrolysis on the basis of NaCl, namely by

- direct electrolysis of a NaCl solution in a cell without a membrane or diaphragm. In the beginning of this century the production of hypochlorite took place in this way. It is, however, impossible to obtain high concentrations; besides, undesirable by-products, such as oxygen and sodium chlorate, are formed. The electrical efficiency was very low and the product had a high NaCl content. As a result this method was abandoned. Nowadays there is again an upsurge of this method, being especially feasible because of the development of new types of electrodes.

- dissolving chlorine gas in a solution of sodium hydroxide, which are both obtained through electrolysis of a NaCl solution in a cell with separated anode and cathode compartments.

The basic technology of the industrial chlorine production is essential to this latter possibility in order to be able to assess which process is most suitable for the in-situ production of hypochlorite. It is therefore useful to give an outline of the current electrolysis processes, complemented by other commercially and non-commercially applied processes.

#### 4.1 Electrolysis of sodium chloride with a diaphragm cell:

The electrolysis takes place in a cell with an anode and a cathode compartment separated by a hydraulically permeable diaphragm.

Electrodes: anode of graphite or coated titanium (DSA)

steel cathode (possibly chrome-plated), Ni, Co, Ti.

This type of cell has been known since 1888; in Germany Griesheim produced a solution of caustic potash with chlorine as a by-product. In the next chapter the diaphragm process will be given special attention in connection with the possibilities for the in-situ preparation of hypochlorite.

#### 4.2 Electrolysis of sodium chloride with a liquid mercury cathode.

This process consists of two parts:

- the electrolysis cell in which brine is electrolysed with a solid anode (graphite, DSA) and a liquid mercury cathode.

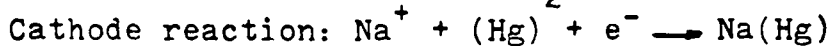
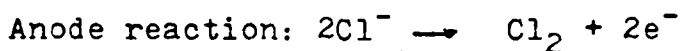

The Na concentration must remain sufficiently low to keep the cathode liquid.

-the decomposition section:

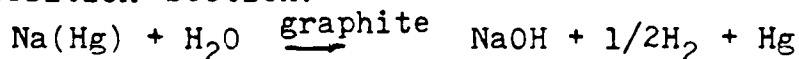

See fig 7.

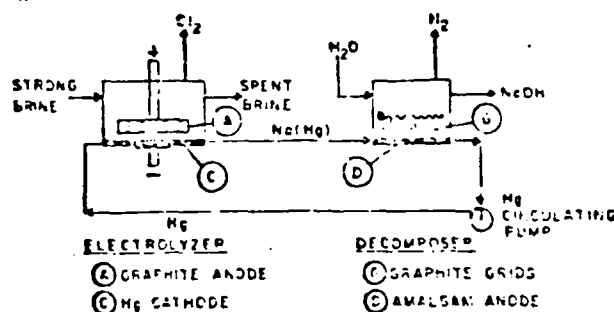
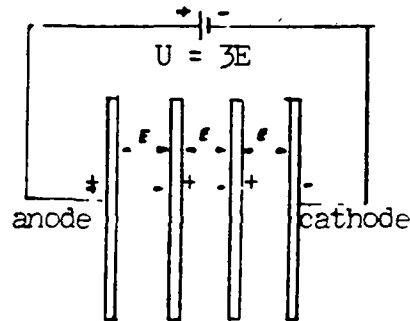

fig 7, uit Sconce<sup>2)</sup>.

### 4.3 Electrolysis of a hydrochloric acid solution.

Hydrochloric acid is a waste acid occurring frequently. There are various forms possible:

- Direct electrolysis of the hydrochloric acid solution. This takes place in a cell according to the filter press type (The Nora cell). Bipolar electrodes are used, i.e. electrodes that function both as an anode and as a cathode, schematically represented according to



bipolar principle.

Electrode reactions:

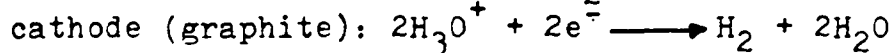
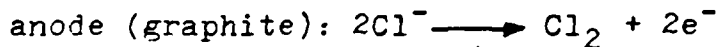

There is a diaphragm between the bipolar electrodes.

See fig 8.

From Sconce<sup>2)</sup>

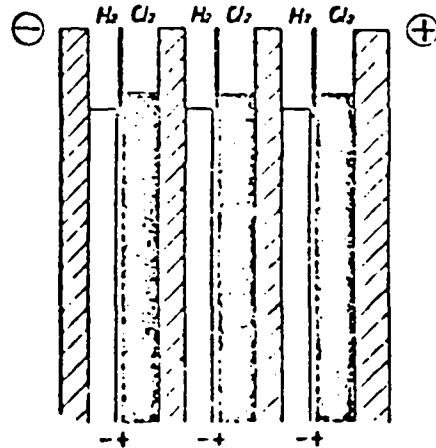

HCl-cell schematic, vertical section.

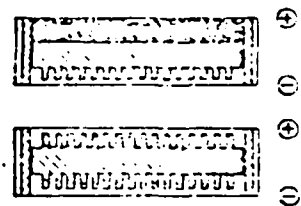

Bipolar cell element from the cathode side and vertical section.

- The Westvaco process.

Principle,

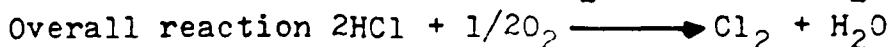
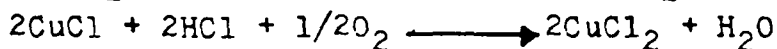
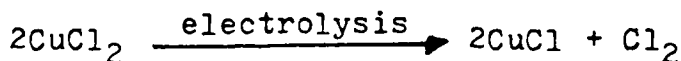

Advantages: pure chlorine

low electrolysis voltage.

The process is not available commercially.

- The Schreuder process.

Principle:

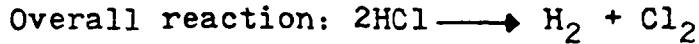
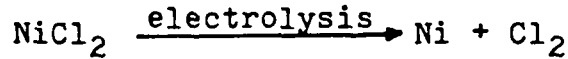

The process is not applied commercially.

4.4 The salt process.

The salt process was introduced after ammonia could be produced cheaply in large quantities (Haber-Bosch). The nitric acid needed for the salt process was now sufficiently cheap to make this process commercially attractive.

The overall reaction is:

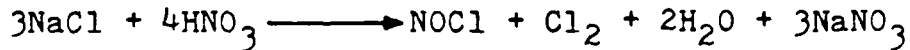

There are two possibilities for the recycling of NOCl:

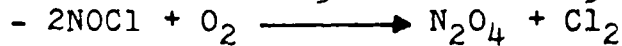
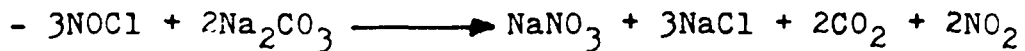

The efficiency depends on the nitrates market.

4.5 The Deacon process.

Principle: Oxidation of HCl in the gas phase with air over a copper catalyst,

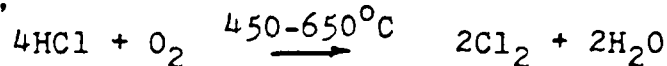

The disadvantages are: - volatile cupric chloride

- low chlorine content in the reaction gas

- poor catalyst activity

After 1920 the process was substituted by the electrolysis processes. Nowadays this process is being developed again in view of its simplicity and low energy requirement. This development resulted in among other things the Airco process and the Fluid-bed Deacon Process.

4.6 Various oxidation processes.

4.6.1 Weldon process (1866)

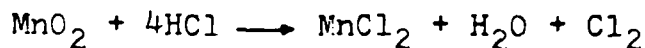

recycling of  $\text{MnCl}_2$  according to



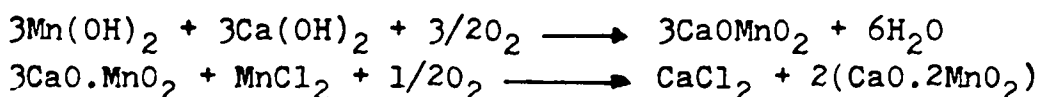

However, the process only has a theoretical chlorine efficiency of 50%.

#### 4.6.2 Hydrochloric acid oxidation by means of $\text{FeCl}_3$ and air.

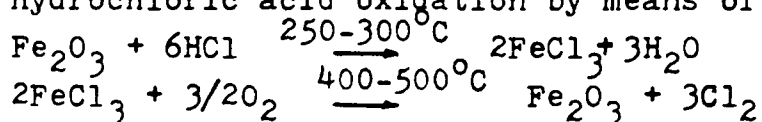

The iron is impregnated on diatomaceous earth and the process is carried out intermittently.

#### 4.6.3 Hydrochloric acid oxidation with $\text{SO}_3$ .

Principle:

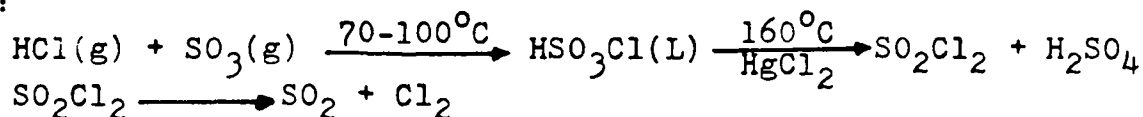

This process is not yet in production, but it offers good prospects.

### 4.7 Process selection for the in-situ production of chlorine/hypochlorite.

Of the industrial chlorine production processes mentioned earlier only the diaphragm process seems to be suitable for a closer examination with regard to the possibility of using this process for in-situ purposes.

The hypochlorite electrolysis cell will of course be considered too.

As to the alternative production of chlorine the Weldon process might offer possibilities. (4.6.1)

One of the raw materials for the Weldon process is  $\text{Ca(OH)}_2$ , which is also required for the preparation of bleaching powder.

A simple preparation of bleaching powder is possible if  $\text{MnO}_2$  is amply available as e.g. ore.

White<sup>1)</sup> gives an outline of this production of bleaching powder in fig 8.

There must be available: sulphuric acid or hydrochloric acid  
sodium chloride or calcium chloride.

Pyrolusite ( $\text{MnO}_2$ )  
 $\text{Ca(OH)}_2$ .

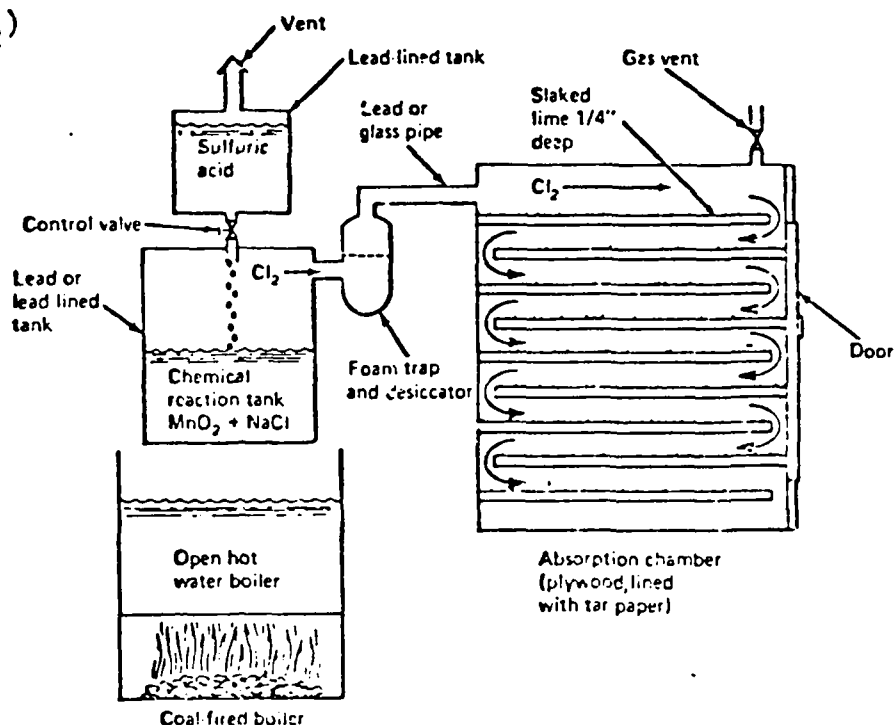

fig 8 schematic diagram of the preparation of bleaching powder in developing countries. White<sup>1)</sup>

### 5.0 Aspects of the electrolysis of NaCl.

The two methods for the in-situ preparation of hypochlorite suggested in the previous chapter are both electrolysis processes.

As such there are some similarities in

- potential chemical reactions on the anode and the cathode,
- problems with regard to the anode material in connection with the corrosive properties of the brine during the electrolysis.

This latter point is one of the biggest problems of the chlorine producing industry. Anodes of graphite have been in use since the beginning of the development of the electrolysis cells. However, they have the disadvantage of breaking off during the electrolysis, so that the anodes must be replaced regularly.

In the last decade a development has been taking place in which anodes are constructed on the basis of the metal titanium. The results that have been achieved with this type of electrode give occasion to assume that within a few years the "old" graphite anode will be replaced entirely by this new type.

The type of electrode is of vital importance for the in-situ hypochlorite generators. This chapter is therefore consigned to, among

other things, the development of the Dimensionally Stable Anode (DSA).

Prior to this a closer look will be taken at the most important reactions in the electrolysis of NaCl.

In this chapter further attention will be given to the working of a diaphragm cell. Insight into the problems of this type of cell is needed in order to understand the development towards the membrane cells.

## 5.1 Chemical reactions in the electrolysis of NaCl.

### 5.1.1 Reactions on the anode and in the anode liquid.

The primary process taking place on the anode is the oxidation of chloride to chlorine gas,

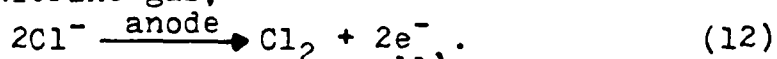

The reversible normal potential is<sup>11)</sup>

$$E_{\text{Cl}_2^g/\text{Cl}^-}^0 : 1.358 \text{ V (25}^\circ\text{C)} \quad \text{and} \quad 1.282 \text{ V (80}^\circ\text{C)}$$

$$E_{\text{Cl}_2^{\text{aq}}/\text{Cl}^-}^0 : 1.396 \text{ V (25}^\circ\text{C)} \quad \text{and} \quad 1.344 \text{ V (80}^\circ\text{C)}.$$

A suggested reaction mechanism is:<sup>12)</sup>



in which the second step determines the rate and at the same time causes the phenomenon of overvoltage, i.e. the extra voltage needed on top of the reversible anode potential in order to obtain a regular electrolysis.

For the forming of chlorine the lowest possible chlorine overvoltage and the highest possible oxygen overvoltage is aimed at. The overvoltage is generally a function of the current density on the surface of the anode.

Electrolysis of water is the principal side-reaction:

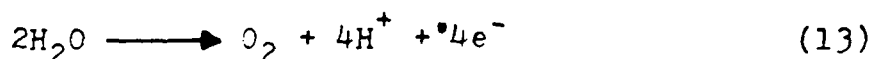

Because of the high overvoltage the development of oxygen is minimal, but it is a function of the current density, pH and the NaCl concentration.

Dissolved chlorine can react with water according to

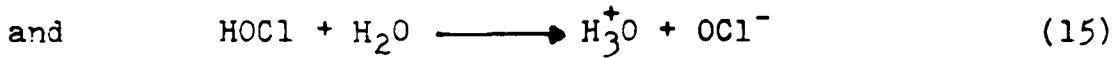
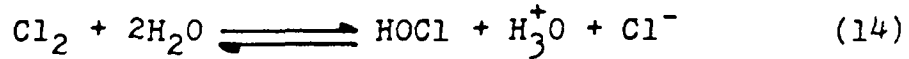

At higher temperatures the forming of chlorate can also occur:

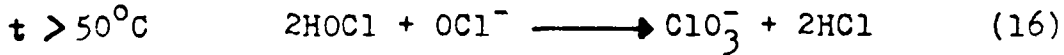

With high pH such as in a hypochlorite cell the forming of chlorate and oxygen occurs according to

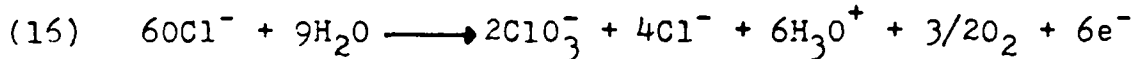

and the forming of perchlorate according to

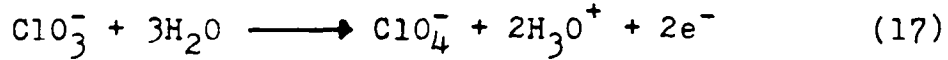

### 5.1.2 Reaction on the cathode and in the cathode liquid.

The main reaction on the cathode is the formation of hydrogen according to:

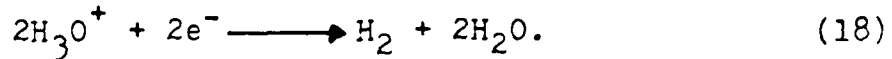

As side-reactions occur:

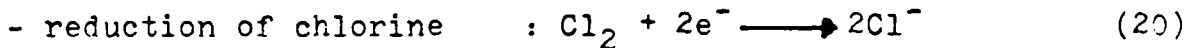
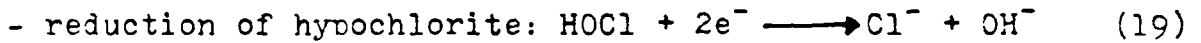

In the cathode liquid the homogeneous reduction of hypochlorite can occur according to

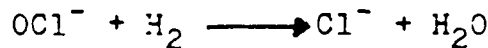

The most important reactions for the diaphragm cell are 12, 13 and 18 and for the hypochlorite cell 14, 15, 16, 18 and 19.

Reaction 19 has the biggest influence on the current efficiency.<sup>46)</sup>

### 5.2 Anodes in the NaCl electrolysis:<sup>14,15)</sup>

Anodes for the electrolysis of a NaCl solution should comply with the following properties:

- good electric conductance
- corrosion-proof
- have sufficient mechanical strength
- have suitable electro-catalytic properties of the surface, so that the overvoltage remains between reasonable limits, but at the same time prevents all competing and possible thermodynamic reactions
- the anodes should be comparatively easy to manufacture



- the possible decomposition products of the anode should not have any or hardly any influence on the electrolysis or its products
- have a reasonable cost price.

At present there are four types of anodes in use on an industrial scale:

1. Graphite
2. Platinum c.q. platinized titanium
3. Magnetite
4. Titanium covered with a film of ruthenium and titanium oxides or oxides of other precious metals.(activated titanium)

The following table gives an outline of the characteristic properties. The advantages of anodes of activated titanium are so considerable that electrolysis becomes cheaper in spite of the more expensive manufacturing.

	Graphite	Platinum	Magnetite	Titanium (activated)
relative electr. conductance	1	100	1/25	20
Chemical durability	average	good	good	excellent
Mechanical strength	average	good	good	excellent
Chlorine overvoltage	average	high	high	very low
Influence of electrolysis process and products	sensitive	hardly any	moderate	none
Costs in relation to graphite	—	much higher	higher	higher
Processing possibilities	simple	difficult	impossible	simple

Next the properties of the various electrodes will be discussed more extensively.

### 5.2.1 Graphite anodes.

Preparation: Ash-free and vanadium-free coke grains are mixed with

a binder, eg. pitch. The substance is brought into the desired form with a hydraulic press. At a temperature of approximately  $1000^{\circ}\text{C}$  the electrode is "burnt" and eventually graphitized at a temperature of  $2600\text{-}2800^{\circ}\text{C}$ .

The final form is obtained by mechanical processing.

Properties:

Such anodes have a density of approximately  $1700\text{ kg/m}^3$  at a pore volume of 20 vol %.

Consumption: about 2 kg graphite per 1000 kg chlorine (diaphragm cell).

Graphite electrodes have a number of disadvantages. The slight electric conductivity and the relatively high chlorine overvoltage lead to voltage losses.

Because of the decomposition of the graphite anode during the electrolysis the cell voltage in diaphragm cells increases in time as a result of the increase in the electrode spacing.

The corrosion of the anodes, furthermore, results in the clogging of the pores of the diaphragm by small graphite grains, resulting in an extra voltage loss over the diaphragm.

A high concentration of chloride normally speaking prevents oxygen formation. In the pores of a graphite anode the concentration of chloride becomes very low, so that oxygen could be formed that can affect the material. It is therefore important to reduce the number of open pores. The pores are filled by "impregnating" the anode with oil. As a result the corrosion is twice as slow.

Hypochlorite in particular seems to contribute largely to the corrosion of the graphite.<sup>8)</sup>

The corrosion occurs roughly as follows: atomic oxygen is formed from  $\text{OH}^-$  and  $\text{OCl}^-$  and is physically absorbed on the surface. Part of the oxygen desorbs as molecular oxygen, the remainder is combined with carbon and eventually desorbs as carbon monoxide. Virtually all the carbon monoxide is oxidized to carbon dioxide. The chlorine that is produced consequently always contains small quantities of  $\text{CO}$ ,  $\text{CO}_2$  and  $\text{O}_2$ . In addition a small quantity of chlorinated hydrocarbon occurs.

## 5.2.2 Metal anodes.

### 5.2.2.1 Titanium with platinum film.<sup>14)</sup>

About 50 years ago Stevens suggested the possibility of constructing anodes from tantalum or tungsten and covering these with a thin layer of platinum.

Because of its micro porosity platinum does not cover the basic material entirely, but sufficiently to allow chlorine production with a low overvoltage.

In practice tantalum anodes are not used, because their price is 30 to 35 times higher than that of titanium.

Tungsten is not very suitable either, because it is very difficult to process.

Since 1950 the price of the metal titanium has dropped considerably, so that it became economically attractive to manufacture metal anodes according to Stevens.

Titanium is a metal that is totally passivable, which means that a titanium electrode which has not been treated will become inactive after a certain period of electrolysis, because the overvoltage rises considerably.

The metal will consequently not be affected.

A very thin layer of platinum (1 micron) can be applied to improve the electro-catalytic properties. The film may be thin, because it does not have a protective function.<sup>17)</sup>

Such an anode, however, does not meet all the economical and technical requirements of the electrolysis.

The consumption of platinum per ton chlorine cannot be neglected and increases even if the electro-catalytic properties are increased (platinum "black").

Furthermore it is a disadvantage that the electro-catalytic properties are not ideal for the forming of chlorine.

With higher current densities the overvoltage rises sharply as a result of a change of the film surface. This change is irreversible and results in a permanent overvoltage of 0.5 V.<sup>11,12,14)</sup> See fig 9.

fig 9  
From 14)

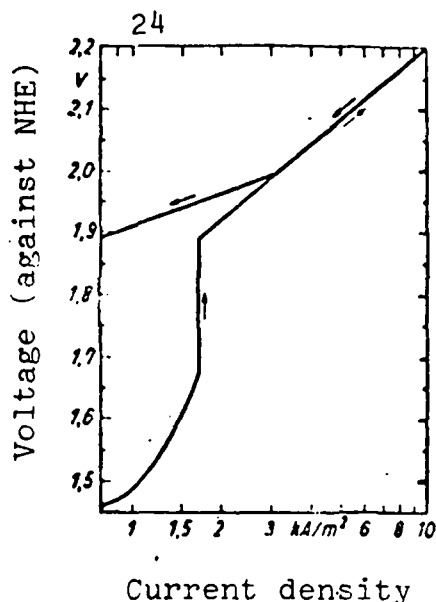

Marshall and Millington<sup>21)</sup> thought that the loss of platinum in a hypochlorite cell could be prevented by selecting the anode potential not higher than 3 V (NHE). (3% NaCl)  
This implies a maximum current density of about 1400 A/m<sup>2</sup>, which appears to correspond with the current intensity at which the anode potential rises so sharply. See fig 9.

The disadvantage of the high overvoltage can be prevented by applying a film of an alloy of platinum and iridium.<sup>11,12,18)</sup> When the film is composed of 70% platinum passivation no longer occurs.<sup>12)</sup>

Khodkevich and others<sup>45)</sup> describe the so-called "pitting" of the Pt/Ti anode in sea water electrolysis. It can be prevented by making the coating thicker or by limiting the current density.

In spite of these satisfactory results there is no industrial application of this type of electrode, mainly because of economical reasons.

#### 5.2.2.2 Titanium anodes with oxide coating.<sup>19,20)</sup>

In view of the disadvantage of the high costs of the Pt/Ir film it was obvious to develop a more suitable active film.

A film of various isomorphous metal oxides which can form solid solutions proved to be particularly suitable. Usually a mixture of TiO<sub>2</sub> and RuO<sub>2</sub> is used.

The basic patents are from H. Beer (ICI); Brit. Pat. 885817 (1958), 1,076973 (1963), 1,147442 (1965) and Belg. Pat. 710551.

There are two methods to construct this type of electrode.

- applying ruthenium electrolytically on titanium from an ammonium

salt solution and then oxidizing it at 450°C to the atmosphere.  
- thermal decomposition of ruthenium chloride ( $\text{RuCl}_3$ ) with or without butyl titanate on titanium (according to Beer Belg. P.710551).

A mixture of  $\text{RuCl}_3$ , butyl titanate and butyl alcohol is "painted" on the etched titanium surface as a viscous fluid.

After that the mixture is thermally decomposed to the atmosphere under specified conditions. These operations are repeated 5 or 6 times until an oxide mixture of about 3 micron is formed.

Hine and others<sup>23)</sup> have examined this coating by means of a technique known as "differential thermal analysis" (DTA), "Thermogravimetric Analysis" (TGA) and Röntgen diffraction.

They showed that  $\text{TiO}_2$  can occur in two crystal modifications, namely anatase and rutile. The rutile form has the corrosion-resistant properties.

The rutile form is only obtained if all three components, i.e.  $\text{RuCl}_3$ ,  $\text{Ti}(\text{OBu})_4$  and metallic titanium occur. In other words: a proper anode is only obtained if a mixed solution of the two components is applied to the titanium.

The experiments show that the electrical resistance becomes lower with a higher ruthenium content. During the NaCl electrolysis, however, 100% Ru is not stable, because the adherence to the titanium surface is not adequate.

The heating temperature also influences the electrical resistance. The lowest resistance is obtained at a temperature of about 400°C.

Bianchi<sup>11)</sup> and Kuhn<sup>24)</sup> assume that the oxide film contains semiconductor properties, which is demonstrated by a negative temperature coefficient of the film resistance.

$\text{RuO}_2$  is considered a metallic conductor and rutile  $\text{TiO}_2$  an n type semiconductor.

At the same time the corrosion-resistant properties are ascribed to this sort of behaviour.

An example of this can be found in Ger. Offen. 2.328.417 (1974) where the anode is built up as a true semiconductor: Silicon with an addition of boron (acceptor, p type) or phosphor (n type, donor). However, nothing is known about the application.

Other oxide mixtures are also applied. The Diamond Shamrock Corp. uses a complex mixture of oxides of precious metals.<sup>36)</sup> (oxides of Pt, Pd, Rh, Re, Ir, and others)

Appendix I gives an outline of the patents of the last few years, not complete but meant to give an outline of the possibilities.

The titanium anodes with oxide coatings have the following advantages:

- The corrosion is very slight; the oxide layer remains unimpaired for a long time (4-6 years), even at high current densities.
- The condition of the surface does not change when chlorine is formed, which is expressed by a stable anode potential.
- The oxides (mixed with  $TiO_2$ ) combine favourably with the under-layer of titanium.
- The overvoltage is lower than that of graphite. (about 0.1 V)
- The resultant gas does not contain  $CO_2$ .
- With diaphragm cells the diaphragm remains operational 2 to 3 times longer.
- Because of the open outlet of the anodes the surface is hardly covered with gas bubbles, unlike the graphite anode where this bubble effect causes an extra loss of voltage.

Because of the invariable form of these metal anodes they are known in industry as the "dimensionally stable anodes" (DSA).

### 5.3 Cathodes.

No special requirements are made on the cathode material. In a standard construction the cathode is made of steel and is constructed as a network of steelwire. The steelwire is laminated, so that a comparatively large surface with small holes is obtained.

In order to reduce the  $H_2$  overvoltage the cathode can be chrome-plated; cathodes of Ni or Co are also used. In small hypochlorite cells with a bipolar construction a cathode surface of titanium is used; the titanium hydride formed has a low hydrogen overvoltage and is corrosion-resistant. Platinum, of course, has the lowest overvoltage, but is affected by the forming of platinum hydride.

#### 5.4 The diaphragm cell.

The cell is divided by a diaphragm in an anode and a cathode compartment. Fresh NaCl solution flows continuously into the anode compartment, where on the anode chlorine is formed, which escapes upwards. Hydrogen is formed on the cathode, whereby hydroxyl ions are left behind in the solution.

A cross section of a diaphragm cell is given alongside. Both a graphite anode and a DSA are shown. From: Uhlmann.<sup>7)</sup>

The lye containing NaCl and the hydrogen gas are conducted from the cathode.

In order to prevent hydroxyl ions from diffusing to the anode compartment, a hydrostatic

excess pressure in the anode compartment ensures that a flow of liquid through the diaphragm is generated in the direction opposite to that of the diffusion of the ions.

The product is evaporated to remove the NaCl from the lye: the end product still contains 1-1.5% NaCl.

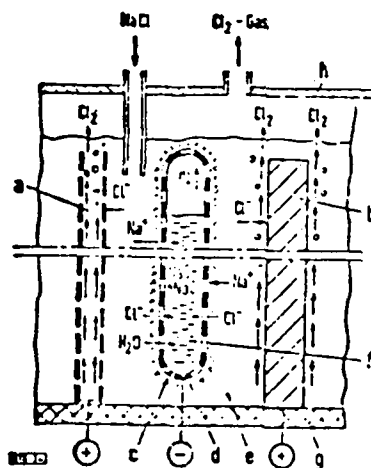

##### 5.4.1 Requirements of the NaCl solution.

In order to prevent the diaphragm from blocking up, Mg, Ca, Fe, Al salts and  $\text{SiO}_2$  must be removed. (with NaOH and  $\text{Na}_2\text{CO}_3$  or ion exchangers).

##### 5.4.2 The diaphragm.<sup>7)</sup>

The function of the diaphragm is to prevent the cathode and anode liquids from mixing. The permeability should, however, be sufficient for the necessary liquid transport. Until now diaphragms on the basis of asbestos have mostly been applied.

There are two construction forms:

- Diaphragms of asbestos paper or asbestos fabric, which are placed on the cathode surface.
- Diaphragms that are prepared in situ by adhering asbestos on the cathode network from an asbestos suspension by means of a vacuum.

The working of the asbestos diaphragm is complicated.<sup>9)</sup> It is assumed that within the diaphragm a gel film is formed, of which the permeability depends on the pH, the rate of flow and the salt content of the passing fluid.

When reducing the pH the permeability decreases. As a result the  $\text{OH}^-$  concentration in the anode fluid increases, resulting in a better permeability. A balance pH is thus formed.

The functioning of the cell and, in particular of the diaphragm can be controlled by regulating the pH and the salt content of the anode liquid; for the proportion of the hydroxide and chloride is coupled to the flow efficiency and the consumption of graphite.

Far more than with graphite anodes the transit time of a cell with metal anodes is determined by the operational life of the diaphragm:

- with graphite anodes 90 to 130 days
- with metal anodes 200 to 400 days.

For this reason improvement of the diaphragms is assiduously being sought.

#### 5.4.3 The cation exchanger membrane.<sup>28,29,30,31,32,33)</sup>

A solution may be found in the development of a cation exchanger membrane.

It is now possible to produce a solution of sodium hydroxide directly with a purity that is comparable to the product of the mercury cell.

Principle:

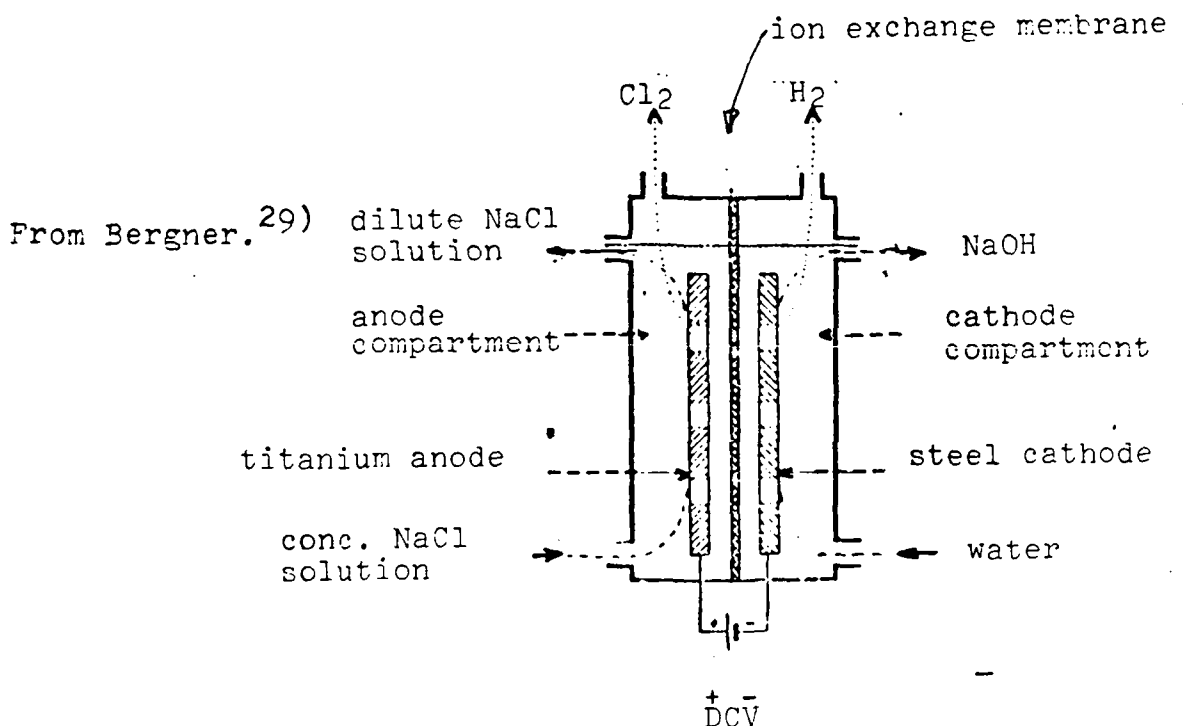



The main reactions are the same as those in the diaphragm cell. Electric transport only occurs through  $\text{Na}^+$  ions that are passed selectively through the cation exchanger membrane.

No liquid transport takes place through the membranes, only the water surrounding the cation goes along.

Equivalent to the transported  $\text{Na}^+$  ion hydrogen is formed on the cathode, whereby hydroxyl ions are formed. So the cathode product is again  $\text{NaOH}$ , but of a considerable purity.

The possibility of carrying out an electrolysis with ion exchanger membranes is described in a French patent of 1954.<sup>27)</sup> The problem was again the durability of the membranes against the environment of the  $\text{NaCl}$  electrolysis.

Du Pont de Nemours, however, produced a membrane from perfluorinated hydrocarbons of the form<sup>28)</sup>

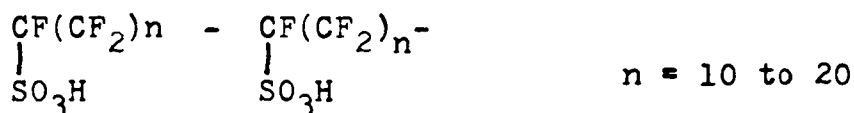

type specification : XR

A further development is the Nafion membrane, also by Dupont:<sup>34)</sup>

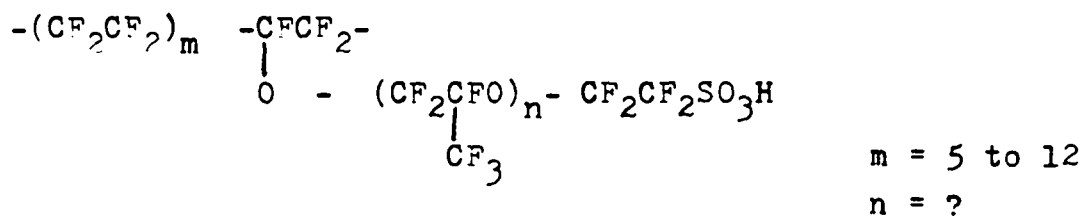

The membranes have the following properties:

- Chemical stability; it is not affected at  $120^\circ\text{C}$  by chromic sulphuric acid, concentrated nitric acid and halogens except fluorine.
- Temperature durability up to about  $200^\circ\text{C}$ .
- High acid content through substitution of  $-\text{SO}_3\text{H}$ .
- Because of the two-dimensional structure of the polymer the processing is easy.

As to the last point the comparison with membranes on the basis of polystyrene is interesting. This type of membrane is often mentioned in Russian articles.<sup>30)</sup>

Uncrosslinked sulphonated polystyrene is water-soluble at a sulphonating content of 25% (1  $\text{SO}_3\text{H}$  group per 32 C atoms). That is why ion exchangers are cross-linked three-dimensionally on the basis of polystyrene in order to limit the swelling in watery electrolytes.

XR and Nafion polymers are uncrosslinked and in spite of a sulphona-  
ting content of 1  $\text{SO}_3\text{H}$  group on 15 to 20 C atoms not soluble in  
water.

The swelling degree of XR and Nafion has a considerable influence  
on the mechanical properties of the membrane. The maximum swelling  
is established by the sulphonate content, which is indicated  
with the so-called equivalent weight ( i.e. the amount of polymer  
in grams which neutralizes an equivalent lye). As a result of a  
proper selection of the equivalent weight the electrical and mecha-  
nical properties of the membrane are determined.

This is illustrated in fig. 10, 11 and 12. in which the properties  
of an XR membrane are described as a function of the equivalent  
weight.

fig.10

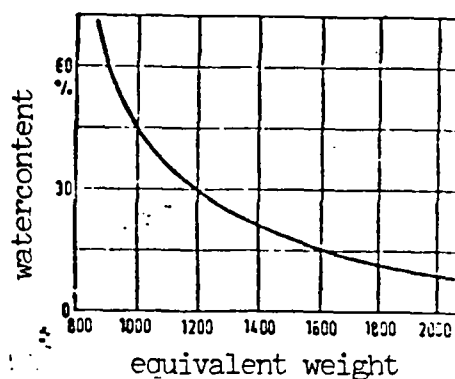
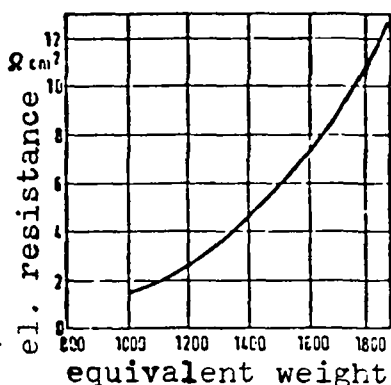

fig 11

Temperature:  $100^\circ\text{C}$   
thickness: about 0.2mm  
( $\text{K}^+$  form

From Grot, 28)

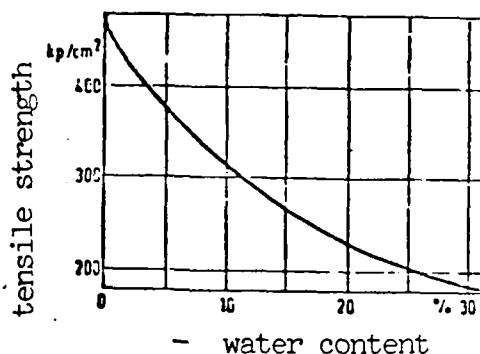
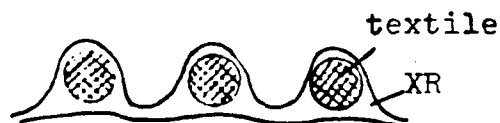

fig 12

Some numerical data of an XR membrane:

thickness	: 0.1-0.2 mm
exchange capacity	: 0.85 mval/g
water absorption in $\text{H}^+$ form	: 25% (30 min boiling)
resistance in 0.6n KCl	: $3\Omega \text{cm}^2$
Perm selectivity in 0.5n KCl	: 90%
Tensile strength ( $\text{H}^+$ form)	: $210 \text{kp/cm}^2$
Change of length when fractured	: 150%

In order to increase the mechanical strength, a textile reinforcement is applied to the XR polymer according to,



With a high lye concentration the current efficiency decreases as a result of the increase in the contribution of hydroxyl ions in the current transport.

The latest development is that this is being suppressed by a chemical modification of the surface layer on the cathode side of the membrane.

This modification consists of converting the sulphonyl fluoride groups over a thin surface layer with ammonia to sulphonamides.

The application of the above membranes is still in the stage of exploratory application in the smaller production units: in Japan Asayi has a factory according to this principle with a production of 25,000 ton  $\text{Cl}_2$  per year.

Appendix II gives an outline of some patents in this field.

## 6.0 Equipment for the in-situ production of hypochlorite.

In the foregoing enough aspects of the industrial chlorine c.q. hypochlorite preparation have been discussed to be able to assess the application of the available equipment for its in-situ preparation in developing countries and remote areas.

It seems useful to compile a sort of package of demands with which the available equipment and construction forms can be put to the test.

The equipment must:

- be cheap,
- have a capacity of 0.25 to 0.50 kg  $\text{NaOCl}$  per 24 hours,<sup>38)</sup>
- be easy to operate,
- not require specialized maintenance,
- preferably not make demands on the quality of the brine. (eg. Mg and Ca contents).

It will furthermore be important whether the equipment will be used

for disinfecting purposes in hospitals and such or whether it will be used for the preparation of drinking water.

As to the disinfection of drinking water two approaches are possible:

- 1- Chlorination by direct electrolysis of the total supply of drinking water.
- 2- Chlorination by dosing hypochlorite to the drinking water. The preparation of the hypochlorite solution takes place through one of the two processes described.

### 6.1 Electrolysis of the total supply of drinking water.

6.1.1 Peters and Hiler<sup>39)</sup> have studied the possibility of directly electrolysing chlorides occurring naturally in drinking water. The advantages of this are:

- no extra chemicals are needed
- dosage through regulating the electric potential of the electrodes.

In the first instance a "chlorinator" with a graphite anode steel cathodes has been studied.

fig. 13 from Peters<sup>39)</sup>

graphite anode:  $335 \text{ cm}^2$   
slit:  $0.64 \text{ cm} \times 15 \text{ cm}$

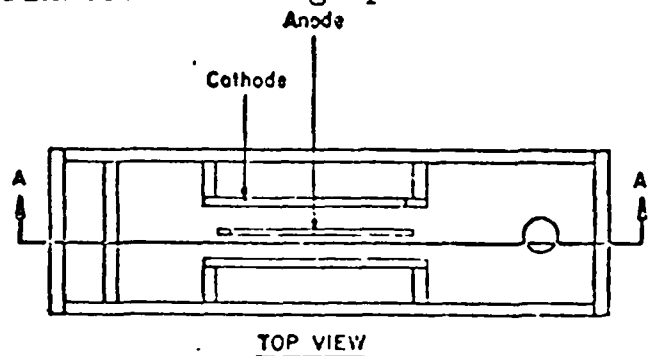

With DSA construction:  
anode:  $2 \times 116 \text{ cm}^2$   
slit:  $0.64 \text{ cm} \times 15 \text{ cm}$

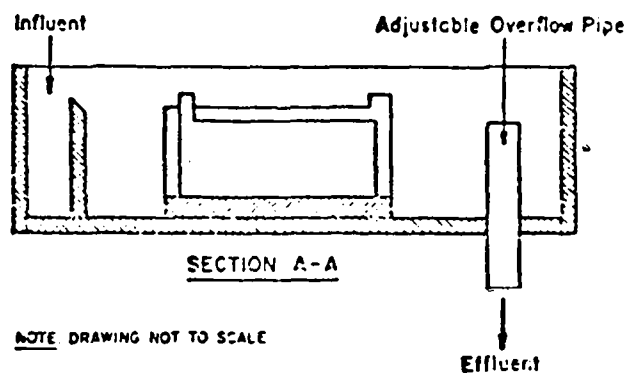

The two steel cathodes were covered with an asbestos diaphragm. Behind the cathode there are compartments with the formed NaOH.

Water with a conductance of  $800 \mu\text{mho/cm}$  and a chloride content of  $50 \text{ mg/l}$  was electrolysed. The results were rather disappointing; the maximum residual chlorine content reached was  $1 \text{ ppm}$ .

As was to be expected at these low chlorine concentrations the graphite electrode was affected very rapidly, resulting in considerable graphite contamination in the effluent.

The electrical resistance increased rapidly as a result of this decomposition of the anode. The current efficiency is 0.5% at the most.

From these experiments it is clear that at a low chloride concentration a graphite electrode is totally useless.

The same equipment was used to examine platinized titanium electrodes. A diaphragm was now not used. With the electrode configuration used a residual-chlorine content is obtained of 4 ppm at the most at a current density of  $0.025 \text{ A/cm}^2$ .

An outline of the results:

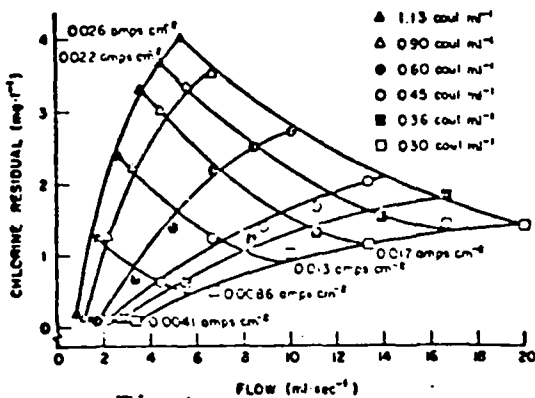

Fig. 14 -

As a parameter the number of electrons per unit of volume is used, expressed in Coulombs/ml. If the electron dosage is to remain constant when increasing the current density, the liquid flow must increase proportionally.

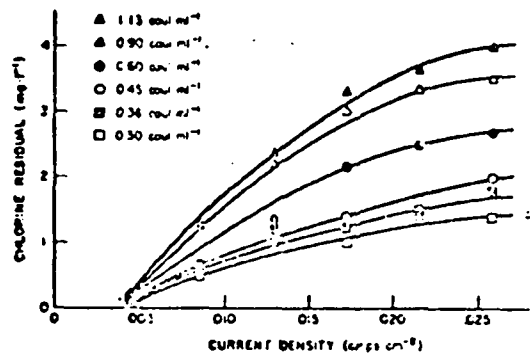

fig 15

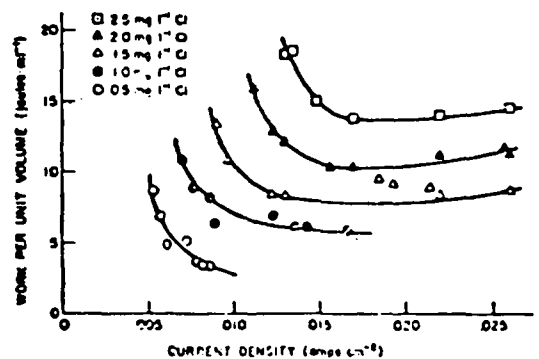

fig 16

The applied cell voltage is not mentioned, but it can be derived from the figures and some of the data in the article. It appears to be approximately 22V.

According to the information from Tjiok<sup>38)</sup> communities of 1000-8000 people with a drinking water consumption of 60 l per day must be reckoned with.

Equipment that is suitable for a unit of one thousand people has the following features if the above principle is used:

- capacity 60,000 l/day, i.e. 2500 l/h.
- power required at a chlorine dosage of 3 ppm and  $\text{Cl}^-$  50 ppm.

$$A_{\text{spec.}} = 0.017 \text{ A/cm}^2$$

$$\text{cell volt.} = 21.6 \text{ V.}$$

power  $W = I.U$  in which  $I = 598 \text{ A}$

$$U = 12.9 \text{ V}$$

the current intensity  $I$  is calculated from:

3 ppm  $\text{Cl}^-$  via fig.14 gives a flow of 4.5 ml/min at an electrode surface of  $228 \text{ cm}^2$ .

The flow should be 2500 l/h, so that the required electrode surface should be:

$$\frac{1000 \times 2500 \times 228}{4.5 \times 3600} = 35200 \text{ cm}^2 \quad (3.5 \text{ m}^2 !)$$

The power becomes 12.9 kW.

Compared to the effect this power is much too high, of course. The electrode surface is so high that this method is unlikely to succeed merely because of this.

The current efficiency is about 0.9 %.

At higher chloride concentrations readings have also been made. At 300 ppm  $\text{Cl}^-$  the current efficiency is about 3.3 %.

Conclusion: The method is not suitable for chlorination of the total flow because of the high energy consumption and electrode costs.

6.1.2 Kuhn<sup>51)</sup> and others report that in the Soviet Union a certain Monastyrskii developed a hypochlorite cell, whereby the cell is filled with grains of graphite or magnetite, serving as a kind of bipolar electrodes.

This principle might be useful for the chlorination of drinking water according to 6.1.1

Principle outline:- make a drain of stainless steel.(cathode)

- use a bar of e.g. magnetite having the same length as the drain and place this bar in the centre of the section of the drain.(anode)
- fill the drain with magnetite or grains of graphite. (bipolar electrodes).
- run drinking water through the drain, so that the grains are inundated and electrolyse.

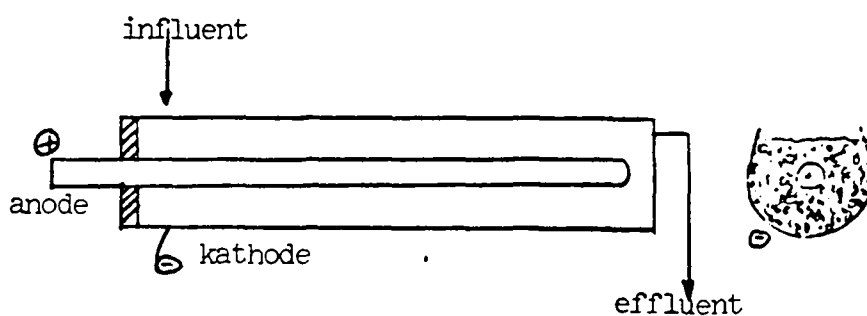

It is expected that the cell voltage will be lower because the conductance does not take place through the water but through the grains, which, of course, should not conduct too effectively. Some research will be needed to find out how the equipment works. The principle, however, is so simple that application in developing countries is obvious.

## 6.2 Hypochlorite dosage to drinking water.

6.2.1 One method for the preparation of a hypochlorite solution was dissolving chlorine in a solution of sodium hydroxide which was obtained through electrolysis of sodium chloride in a diaphragm cell or membrane cell. In general this method leads to rather concentrated hypochlorite solutions.

The available equipment will now be discussed.

### 6.2.1.1 The diaphragm cell.<sup>40,43)</sup>

Michalek and Leitz<sup>40)</sup> examined the applicability of the diaphragm cell for the "in-situ" hypochlorite preparation. They developed a cell from the familiar principle with a diaphragm of asbestos; experiments with a diaphragm of teflon showed that its electrical resistance was too high. The cathode and the asbestos diaphragm (from a fuel cell!) were separated by a polypropylene screen. The main disadvantage of this cell was the vulnerability of the asbestos diaphragm. The usual slurry method is not to be desired, because it requires specially trained staff.

Such a type of cell can only be used in developing countries if a solution can be found for the diaphragms, either by developing diaphragms that can be used for a lengthy period of time or by "disposable" diaphragms.

Further disadvantages are:

- poor salt utilization (50 % conversion)
- accurate setting of the levels in the compartments and of the brine supply is required to prevent contamination of  $H_2$  and  $Cl_2$  through the diaphragm.
- interruptions in the liquid supply upset the electrolysis conditions directly and often lead to the contamination mentioned earlier.
- the brine should be softened, because Mg and Ca hydroxides obstruct the diaphragm.

Michalek and Leitz thus concluded that this method was not suitable as an "in-situ" process.

#### 6.2.1.2 The membrane cell. (Chloromat)

Michalek and Leitz <sup>40)</sup> give the results of the development of a cell that is equipped with a Nafion or XR membrane, DSA and steel cathode. The apparatus can be operated in two ways.

I

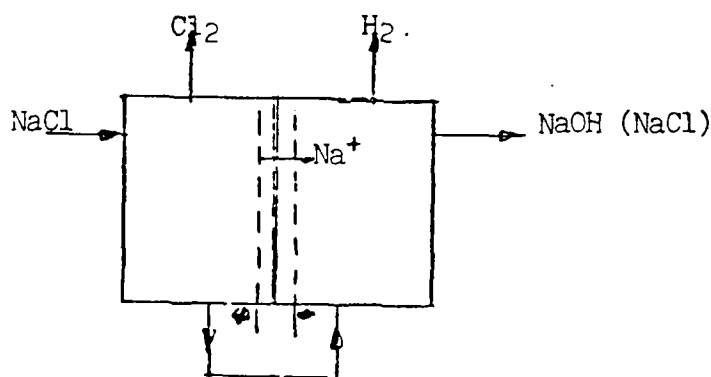

With this construction the diluted solution is conveyed to the cathode compartment. The advantage is that only one supply pump is needed and that "flow balancing" is redundant.

Disadvantages:

- the  $NaOH$  concentration cannot be varied without changing the salt utilization.
- loss of salt.

II

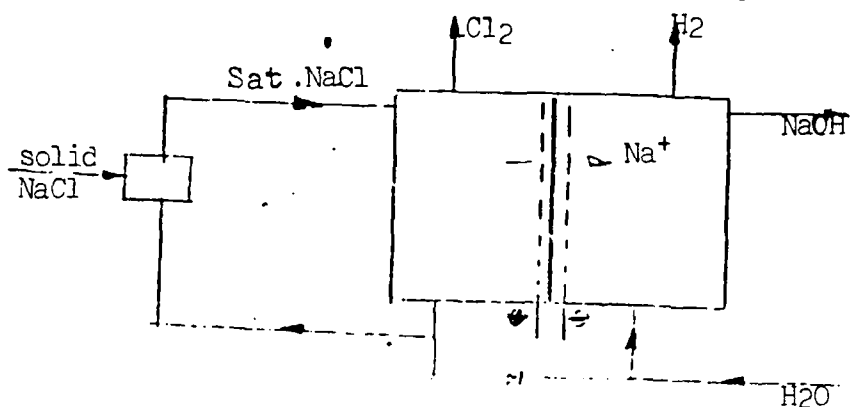



With this construction the cathode compartment can be supplied with water or a diluted salt solution. In this arrangement the NaOH concentration in the cathode compartment can be regulated independently from the salt utilization, so that II is somewhat more flexible. The design, however, is more complicated and requires more pumps and auxiliary equipment.

It depends on the availability and price of the salt which design is cheaper. Normally the highest possible utilization of the salt will be sought, so that method II with water as a supplier for the cathode compartment is preferred.

For the preparation of hypochlorite the system is enlarged with a cooled reactor, leading to the following principle diagram of the equipment developed.

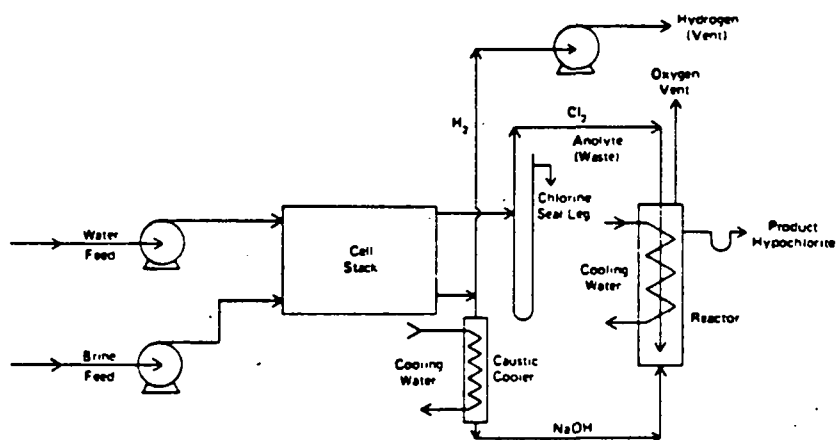

Principle diagram of the Chloromat, from Fiedler<sup>41)</sup>.

Some data and conditions for processing.

cell design	: filter-press type
anode surface	: 0.2 m <sup>2</sup>
current	: 525 A
current density	: 2580 A/m <sup>2</sup>
cell voltage	: 3.7-3.8 V
cell temperature	: 87-89°C
supply (sat. NaCl solution)	: 58 ml/min/cell
degree of salt utilization	: 81%
water supply	: 110 ml/min/cell
NaOH	: 2-2.3 n
hypochlorite prod.	: 135-140 ml/min/cell (6%)
electric efficiency	: 77%
energy consumption	: 3.52 kWh/kg NaOCl
salt consumption	: 2.1 kg/kg NaOCl

Durability of some of the components.

- membrane : tested approximately 3000h., expected operational life of 2 years.
- Electrodes : DSA, the expected operational time is at least 3 years, after which recoating is possible.
- Cell frame : Temperature constant, only the surface is affected, no further corrosion.

Costs:

Fiedler<sup>41)</sup> gives an outline of the production costs for different capacities. Michalek mentions an amount of \$ 60,000 for the investment costs of a unit with a capacity of 454 kg/day.

It is difficult to estimate what a piece of equipment with a capacity of 0.5 kg/day will cost; a piece of equipment with such a small capacity is probably not directly obtainable. Estimate: \$ 3000.

Water treatment<sup>44)</sup>:

The process water should not be hard.

Mg, Ca	20 ppm
Fe	2 ppm

Purification steps: water softener followed by a manganous zeolite treatment and filtration.

This hypochlorite generator is known as the "Cloromat" of Ionics Inc. Watertown Mass. USA.<sup>42)</sup>

Summary:

Advantages:

- the apparatus operates fully automatic
- requires little attendance
- consumes comparatively little energy.

For a capacity of half a kilogram NaOCl per day a generator of 0.5 kW seems amply sufficient.

- high salt utilization
- can produce hypochlorite in a solution of up to 15% NaOCl
- does not cause contamination of H<sub>2</sub> and Cl<sub>2</sub>.

Disadvantages: (with respect to use in developing countries.)

- probably very expensive; one should count on Dfl.10,000 for a complete installation.

- the apparatus is constructed to compete with a system such as chlorination with liquid chlorine. The rather expensive construction is designed for safety, easy operation and use in developed areas. It has never been the intention of the designers to have the Cloromat operate in remote areas and developing countries. The specialized technology applied in the apparatus requires highly qualified staff to repair any failures, something that can hardly be expected in developing countries.
- requires water treatment.

Conclusion: For use in developing countries the Cloromat in its present form does not seem suitable because of: price and being too "sophisticated" for developing countries.

It should be noted, however, that the principle of the apparatus does seem suitable.

A less complicated design can be attractive.

#### 6.2.1.3 The Cooper cell. (U.S. P.3,390,065)

The Cooper cell, like the Cloromat, makes use of a cation exchanger membrane.

After hydrogen has been separated the chlorine gas and the lye are mixed in a reaction chamber.

See drawing from the patent on p.40

The anode is cooled and is thus able to keep the temperature of the electrolysis below 50°C in order to suppress the forming of chlorate.

The temperature of the reaction chamber is between 10 and 35°C.

As feed a saturated NaCl solution is used plus water.

The used NaCl solution still contains 2-5% NaCl.

Salt utilization: 2.5 kg/kg NaOCl.

Hypochlorite conc.: 5-12%.

Both electrodes have as a basis titanium; the cathode without film, the anode is platinized titanium.

June 25, 1968

HAL B. H. COOPER  
 PROCESS AND CELL FOR THE MANUFACTURE OF EITHER  
 SODIUM HYPOCHLORITE OR CHLORINE

3,390,065

Filed April 3, 1964

2 Sheets-Sheet 2

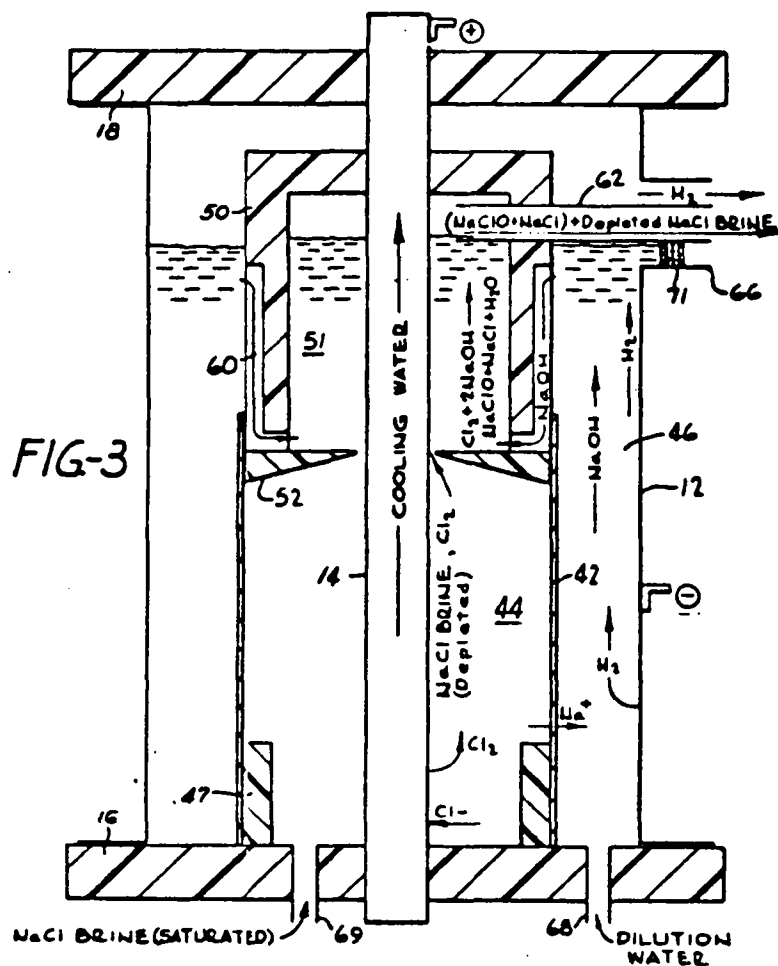

There is a possibility to construct both tubes in graphite; this, however, is not so attractive because of the corrosion. When the patent was issued (1968) the XR and Nafion membranes had as yet not been developed.

The disadvantage of the vulnerability of the membranes mentioned in the patent will be removed with the use of these new membranes.

In addition to the production of hypochlorite chlorine can also be produced, simply by cutting off the supply of NaOH to the reaction chamber.

The Cooper cell is special in that the anode and the cathode are bi-functional. The inner electrode, the anode, also functions as a cooling system for the electrolysis<sup>cell</sup> and the reaction cell. The outer electrode, the cathode, furthermore functions as a housing area and ensures an

air-cooled surface.

As a result of this construction the temperature in the apparatus can remain low and thus achieve high conversions to hypochlorite.

Suitable construction materials: PVC, PENTON and Teflon.

Data about the current efficiency are not available, but it is expected that it is in the same neighbourhood as that of the Cloromat. (70-80%) The required cell voltage will probably be higher than that of the Cloromat, because the distance between the electrodes will be larger. Estimate: 6 V.

Production capacity: no information in the patent.

Assuming a current density of  $1000 \text{ A/m}^2$  and a current efficiency of 70 % the size of the apparatus with a production of 0.5 kg NaOCl/day is:

diameter tube : 2.5 cm  
length : 60 cm  
diameter : 10 cm

Energy consumption at a cell voltage of 6 V: 6 kWh/kg NaOCl.

Requirements of the feed : water and brine must be softened. On the whole the same applies<sup>as</sup> to the Cloromat.

Summary of the Cooper cell:

#### Advantages

- a particularly compact apparatus of very reliable construction. The only vulnerable part is the membrane, but with the use of an XR or Nafion this is no longer a problem.
- a rather high salt utilization.
- probably a high current efficiency.
- its construction seems cheaper than that of the Cloromat.

#### Disadvantages

- water softener is required.
- except in 44) the Cooper cell is not mentioned in the literature, so that little is known about the practical application of the apparatus.

Conclusion: Because of its simple construction the Cooper cell seems to be more suitable for use in developing countries than the Cloromat.

Yet this apparatus is not suitable for universal application in these countries. The conditions must be such that the control of the supply pumps and the temperature in the cell should not run up against great difficulties; so, application

possible, but with certain restrictions.

6.2.1.4 Hypochlorite generator, developed by F.J.Scoville.

U.S.Pat. 3,962,065

This cell is equipped with oil-impregnated graphite electrodes and operate as a bipolar cell.

Two designs are described; one for the preparation of hypochlorite, the other for the preparation of chlorine. As a result of the arrangement of the bipolar electrodes chambers are formed which are separated by a membrane in an anode compartment and a cathode compartment. The membrane (porous propylene) is called a  $\text{Cl}^-$  permeable membrane by the inventor.

On closer inspection, however, a membrane is referred to here that is not selective for chloride, but allows all ions through, in other words, the membrane is a variation of the asbestos diaphragm.

A remarkable aspect of the apparatus is that no effort is made to prevent contamination of hydrogen and chlorine, which implies a certain amount of risk (the danger of explosion when subjected to direct sunlight). The apparatus must consequently be equipped with a liquid gas separator before the hypochlorite can be used.

According to the construction it appears that as to operation the cell is an intermediate form between the diaphragm cell and the membrane cell.

In the diaphragm cell the liquid is forced to run through the diaphragm to the cathode compartment; this compartment has consequently no separate supply. In the Scoville cell the liquid is not forced to go through the diaphragm, just as in the membrane cell. The liquid transport through the propylene membrane takes place through diffusion, in which the osmotic pressure plays a role.

As a result of all this a small, rather concentrated flow of lye will probably run out of the cathode compartment, mixing with the larger flow of liquid from the anode compartment.

The inventor claims that alkaline earth chlorides can also be used. This is questionable, however, because the cathode compartment will always contain sedimentation and will influence the proper functioning of the apparatus. It is possible, however, that a sort of stationary condition is created, whereby from a cathode compartment filled with sedimentation the hydroxides are dissolved as hypochlorite.

FIG. 1

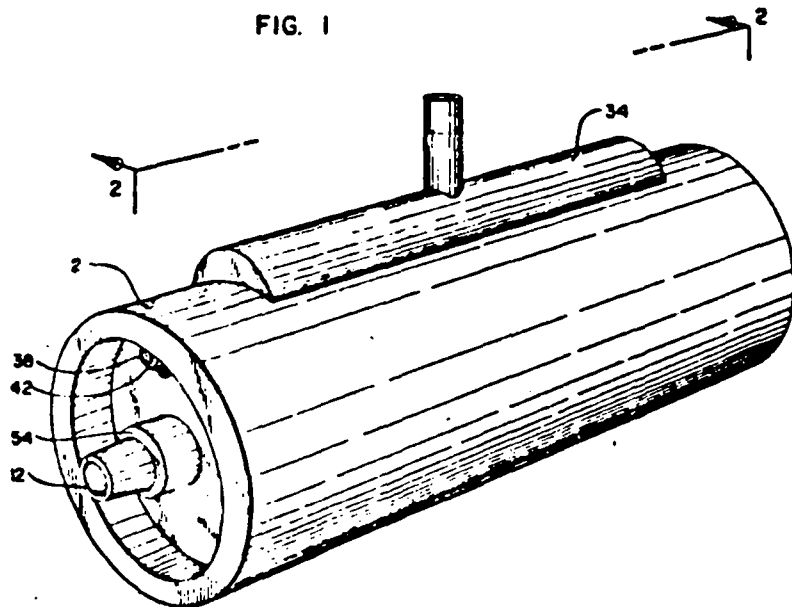
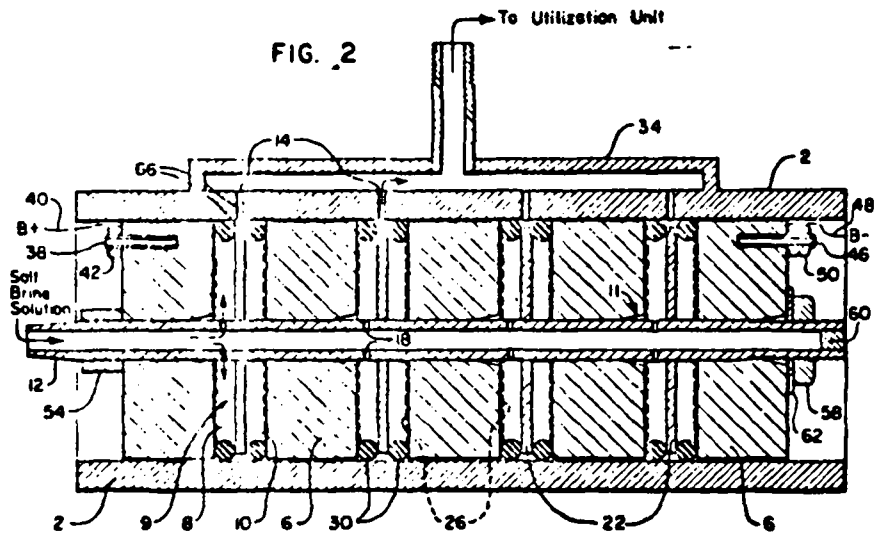

FIG. 2



Nothing is mentioned on the corrosion of the electrodes; it is known, however, that bipolar graphite electrodes are less rapidly affected. In the case of severe corrosion, as a result of which the cell would no longer function properly, the electrodes can be replaced rather easily.

No information is given on the current efficiency, content of the salt solution, salt utilization and content of the hypochlorite solution.

Furthermore, the apparatus is not known in commercial literature.

#### Summary:

Advantages: - simple and compact piece of apparatus.  
- cheap graphite electrodes.  
- bipolar circuit: this means high voltage and low current intensity, so that a cheaper rectifier can be used.  
- simple operation, only one supply pump is required.  
- the supply need not be softened.  
- variable capacity because the number of electrodes can be changed.

Disadvantages: - contamination of hydrogen and chlorine entails a certain amount of risk.  
- It is certain that the graphite electrodes will not last longer than one year. New electrodes must always be available, which could be problematic at times.  
- no actual information is available as to the functioning of the apparatus.

Conclusion: The apparatus is potentially suited for use in developing countries for the in-situ preparation of hypochlorite. There is, however, a restriction as a result of the uncertainty about the functioning of the apparatus.

Note: The principle described above may lend itself for an independent development of a hypochlorite cell.

In order to avoid the patent mentioned above DSA electrodes are used, whereby hydrogen could be separated first before mixing chlorine and NaOH.



Principle diagram:

porous diaphragm  
e.g. Teflon or  
polypropylene

Feed-NaCl solution

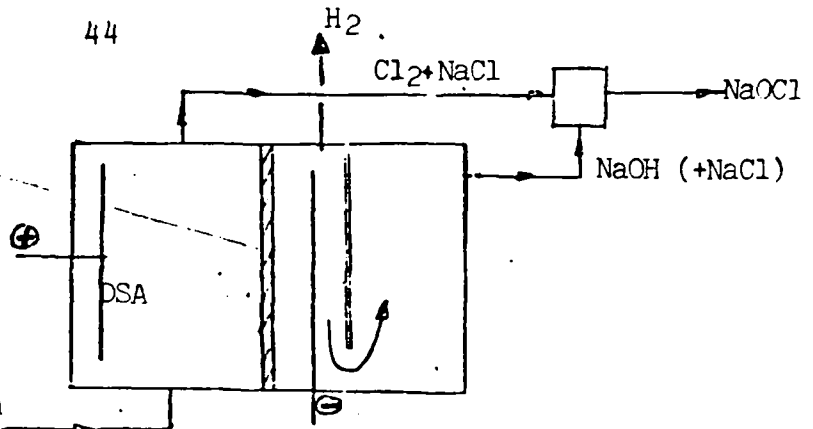

The advantage as compared with a diaphragm cell is that no flow balancing is required.

6.2.1.5 The Griesheim cell.<sup>2)</sup>

The first commercial production of chlorine took place in the so-called Griesheim cell. This cell was equipped with a diaphragm of porous cement.

The diaphragm was prepared by mixing Portland cement and NaCl, after which it was lixiviated with water to remove the soluble salts.

The figure below shows the construction of the Griesheim cell:

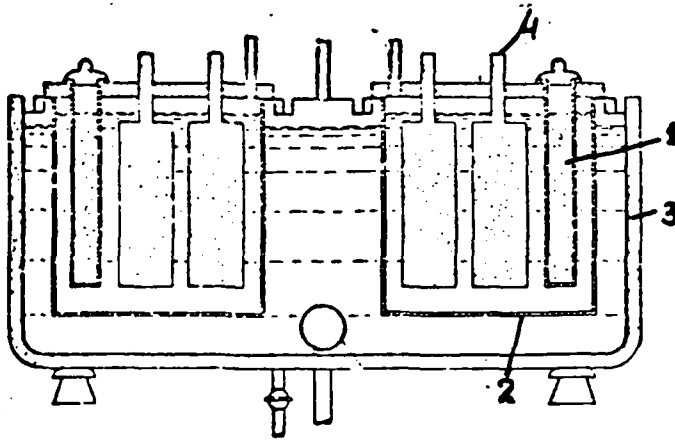

- 1. salt supply container
- 2. cement diaphragm
- 3. steel cathode
- 4. graphite anode (also magnetite)

The cell is operated batch-wise. The salt supply is contained in porous jars. The diaphragm can only be permeated by ions, so that the flow mainly takes place by  $\text{Na}^+$  ions. The current efficiency was low and was in the neighbourhood of 80 %. Because of its simplicity and very cheap construction this cell is worth considering for use in developing countries, especially in those areas where only the simplest and cheapest possibilities are considered.

The batch process must be so carried out that the chlorine produced

should run into a container with lye, not into the cathode compartment of the cell.

### 6.2.2 Hypochlorite cells without membranes.

In this type of cell the conversion into hypochlorite is limited and varies from 0.1 to 2.5 % hypochlorite depending on the method, whereby the solution still contains a considerable amount of NaCl.

This low concentration is caused by the occurrence of competing reactions, resulting in the loss of hypochlorite.

Bennett<sup>46)</sup> gives an outline of these reactions and describes its contribution as a function of the conversion.

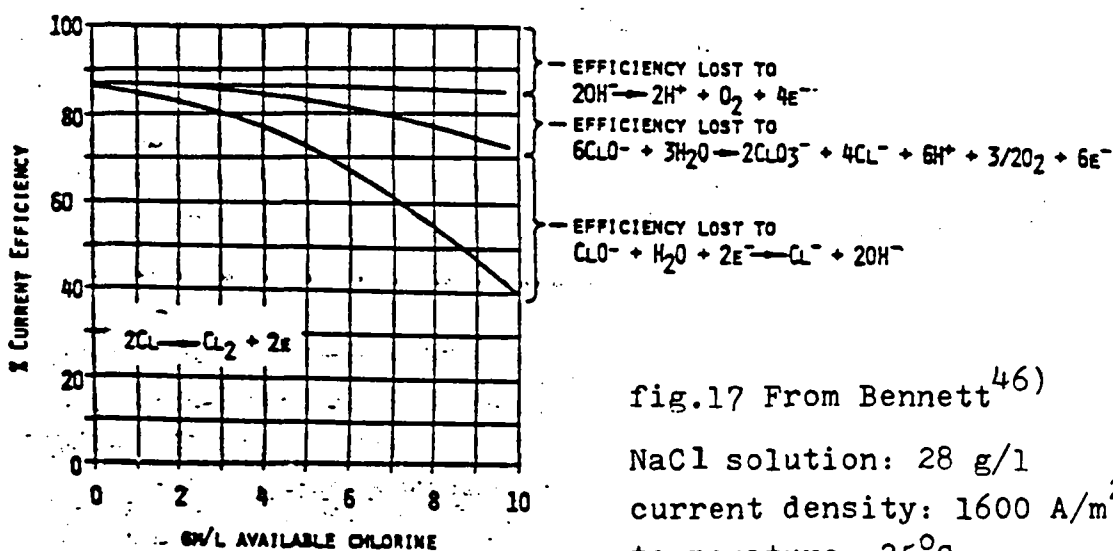

fig.17 From Bennett<sup>46)</sup>

NaCl solution: 28 g/l

current density: 1600 A/m<sup>2</sup>

temperature: 25°C

DSA

The figure shows that the contribution of especially the cathodic reduction of hypochlorite strongly depends on its concentration. It has furthermore been established that at a higher current density a higher efficiency is obtained; the production of hypochlorite will then apparently predominate with regard to the diffusion to the cathode.

The anodes in the hypochlorite cells are mainly platinized titanium and titanium covered with oxides.<sup>48)</sup>

In a few cases a coating of PbO<sub>2</sub> on graphite or titanium has been used. (Pepcon cell.)<sup>30)</sup>

Kuhn<sup>47)</sup> gives an outline of the possible constructions that are feasible with a hypochlorite cell.

Depending on the availability of NaCl another construction is chosen.

## 1 - The "Once through" system.

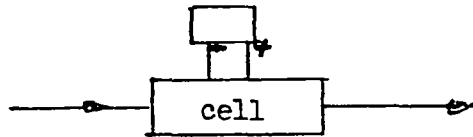

This is applied when sea water is available. The product is a diluted solution of 0.1 % hypochlorite.

## 2 - The "Once through" system with solid salt.

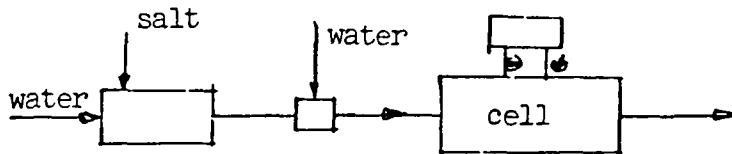

If solid NaCl is comparatively cheap and the investments remain low, this system is used. An advantage of method 1 is that the fluid flow rate in the cell need not be so high to prevent deposit of hydroxides.

The supply consists of 3 - 3.5 % NaCl.

## 3 - The sea water recycling system.

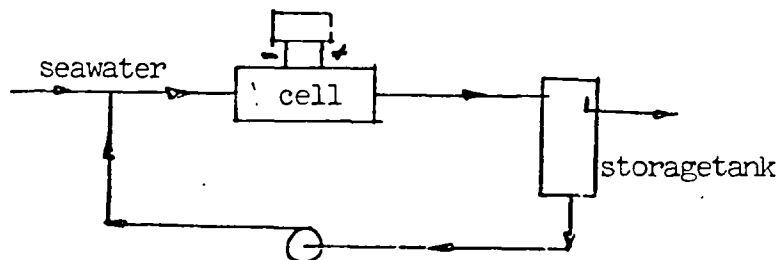

In order to obtain a somewhat higher concentration of hypochlorite the effective duration in the cell is increased by recycling. The rate in the cell must remain high to prevent deposit of the electrodes. A concentration of 0.5 % hypochlorite is realizable.

## 4 - Sea water recycling with cooling

Construction: the same as 3 but with cooling in the recycling circuit.

The concentration can be approximately 1 % hypochlorite.

5 - Brine recycling with cooling.

Construction: the same as 2 but a cooled recycling included.

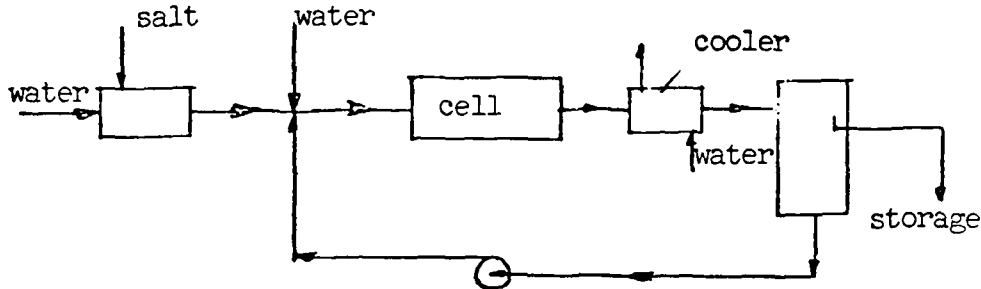

Which method is eventually chosen depends on local factors with regard to the availability of NaCl and the financial possibilities. Regarding the developing countries the "once through" method seems to be the most attractive one because of the simplicity of the process.

The "once through" method offers the opportunity to control the dosing in a simple way.

With a constant concentration of salt the cell voltage determines the current intensity through the cell. The liquid flow will, within reasonable limits, have no influence on the current efficiency. This means that the total amount of hypochlorite produced is only a function of the cell voltage, so that only a calibration is necessary of the residual chlorine concentration against the cell voltage at a certain flow.

If the product is dosed directly, only the cell voltage will in principle have to be adjusted to the drinking water flow.

The modern equipment that is available is characterized by narrow apertures between the electrodes, primarily to limit drops in voltage. As a result the rates of the liquid are always rather high, which is sometimes desirable (in order to prevent deposits on the electrodes) but which also leads to loss of hypochlorite. With a laminar flow transport of hypochlorite occurs only by diffusion, so that its concentration on the cathode can remain low. Turbulence thus increases the concentration of the hypochlorite on the cathode, as a result of which more reduction will occur.

The equipment mentioned hereafter will in most cases have a higher capacity than the desired 0.5 kg NaOCl/day.

Should delivery of apparatus with smaller capacities not be possible, the production will have to take place discontinuously. This will have consequences for the investments, namely:

- supply container
- more expensive dosage system
- larger capacity of the rectifier and/or generator.

The majority of the equipment will in principle be suitable for application in developing countries. Equipment that does not require softening of the salt solution is preferable.

The choice will furthermore be determined mainly by the price.

#### 6.2.2.1 The Pepcon cell. <sup>51,52,44,57)</sup>

An important cell is the standard Pepcon cell of Pacific Engineering and Production Co. of Nevada.(Pepcon.)

Sales in the U.S.A. by Morton Salt Co., Chicago. <sup>52)</sup>

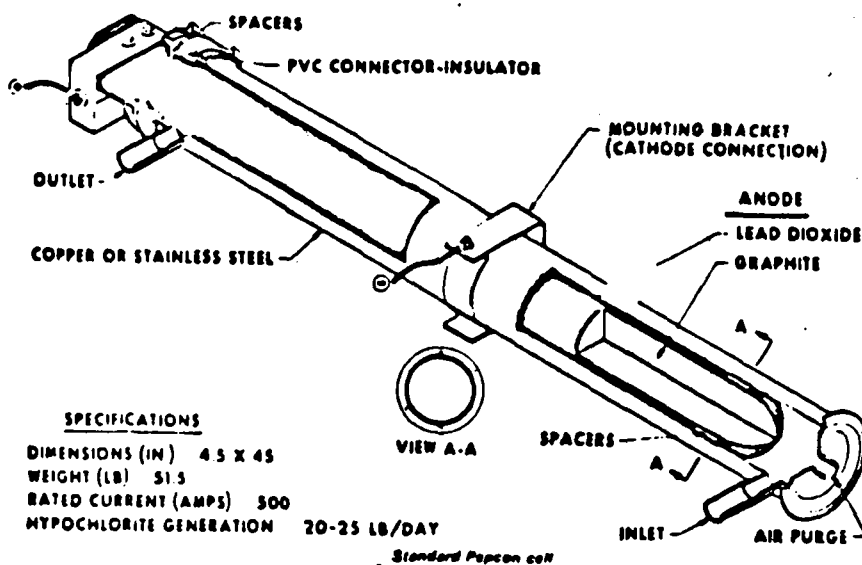

fig.18, from Jones <sup>52)</sup>

Use is made of a small aperture between the cathode and the anode. The anode consists of graphite or titanium which is covered with a thin layer of  $PbO_2$ .

Kuhn <sup>51)</sup> suggests that  $PbO_2$  works more efficiently than platinized titanium, graphite and magnetite, although in another article by Kuhn <sup>47)</sup> the advantages of  $PbO_2$  on graphite are questioned.

The reached hypochlorite concentration with the Pepcon cell is approximately 0.5 % at a cell voltage of 4 to 5 V. Usually several cells are used in series and parallel in order to achieve a greater capacity.

Fig. 19 gives the current efficiency as a function of the conversion and the temperature.

The production of one cell amounts to approximately 10 kg NaOCl/day.

Energy consumption: 6.6 - 8.6 kWh/kg NaOCl

salt consumption: 3 - 3.5 kg/kg NaOCl

no water treatment is required.

Power : 2.25 kW for a standard cell.

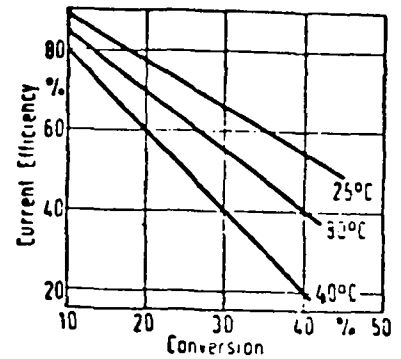

fig 19

#### 6.2.2.2 Sanilec cell.<sup>44,46,51)</sup>

U.S. Pat. 3,779,889 (1973)

" " 3,849,281 (1974)

Bennett<sup>45)</sup> describes the measurements that led to the development of a cell that is described in the U.S. Pat. 3,849,281.

This piece of apparatus is a "multi-stage" hypochlorite cell, equipped with bipolar DSA electrodes of a special form. See the drawings from the patent at p.49b.

The electrode material consists of titanium, of which the anode side is covered with a platinum film or oxides.

In this cell high liquid rates are not used, so that the supply should preferably not contain magnesium and calcium.

Sanilec is a trade mark of Diamond Shamrock Corp.<sup>46)</sup>

The sanilec cell operates on sea water and purified brine.

Product: 0.8 % NaOCl

Energy consumption: 5.5 kWh/kg NaOCl

Production: 10 - 1000 kg/day

Supply: preferably softened

Salt consumption: 3.5 kg/kg NaOCl.

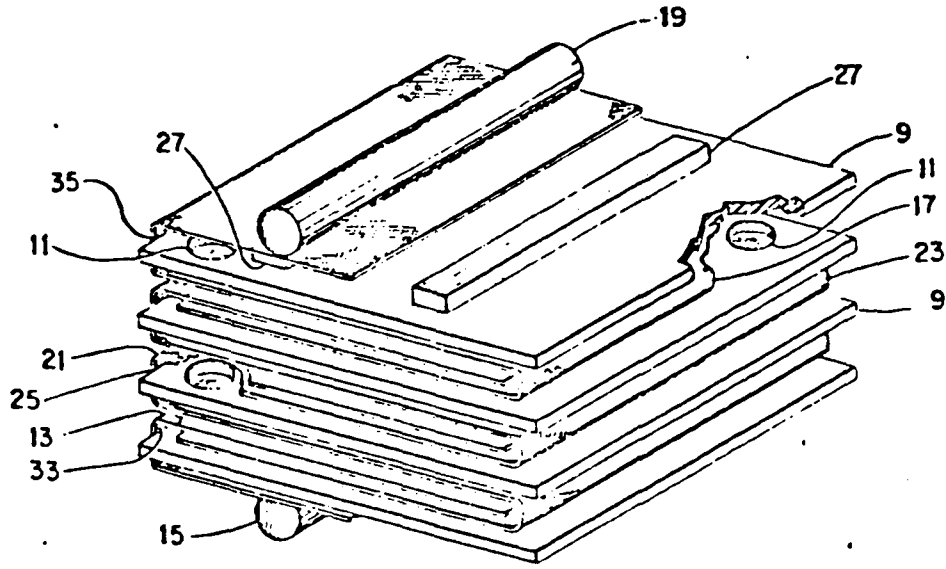

Fig. 1

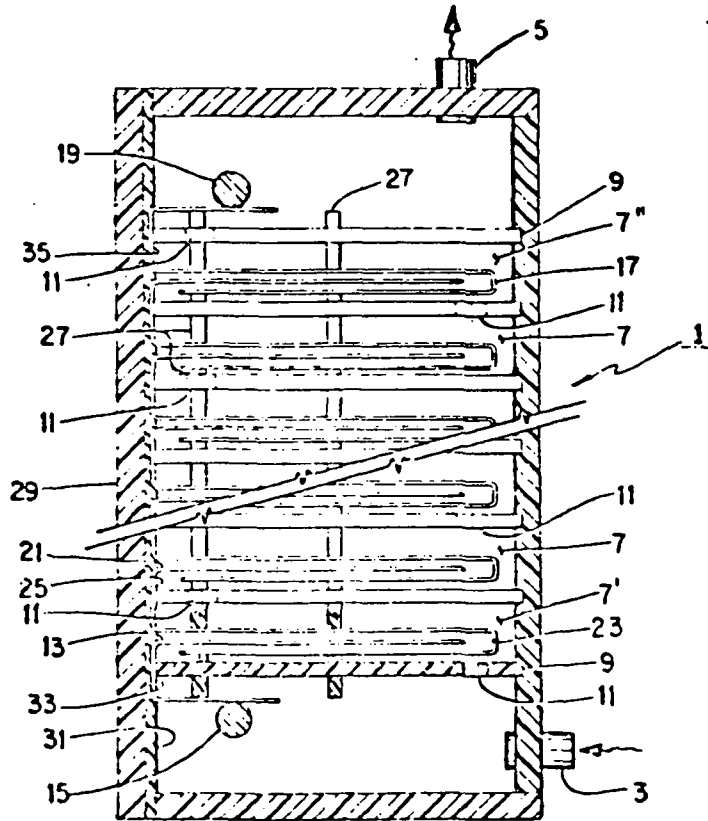

Fig. 2

SANILEC-CEL.

### 6.2.2.3 The Engelhard cell.

Ger. Offen 2.244.020. (1972)

The Engelhard cell is based on the principle of the "floating dipole", implying that this electrode has no electric contact whatsoever.

fig.20, from Kuhn<sup>47)</sup>

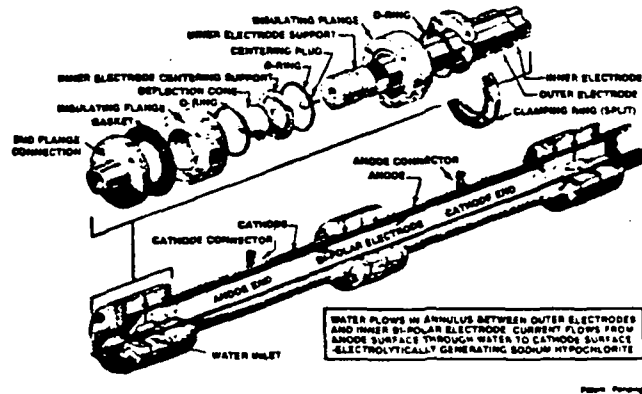

Schematically represented:

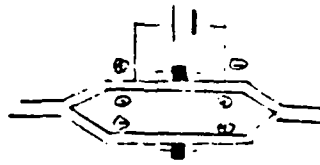

The outside consists of two halves, which are isolated yet connected, of which one side is connected anodally and the other cathodally. In both tubes there is, concentrically, another tube which is not connected electrically.

Depending on the polarization of the covering part of the tube, the "floating bipole" either functions as a cathode or<sup>as</sup> an anode.

The bipole consists of titanium which is platinized on the anode side.

Rate in the slit: approximately 3m/s

Energy consumption: 6.1 kWh/kg NaOCl.



1,267,516 COMPLETE SPECIFICATION  
3 SHEETS This drawing is a reproduction of  
the Original on a reduced scale.  
SHEET 2

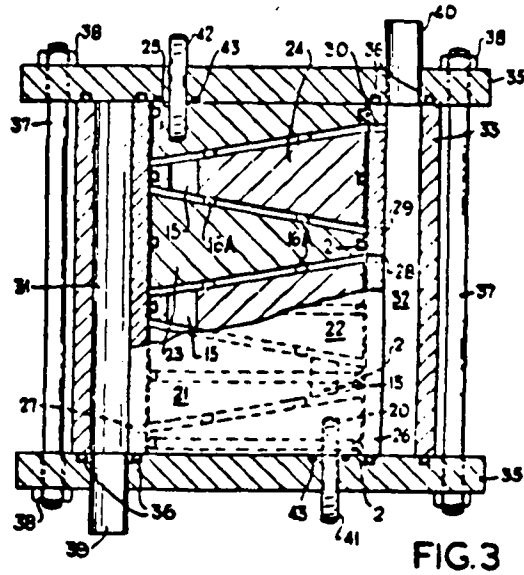

FIG. 3

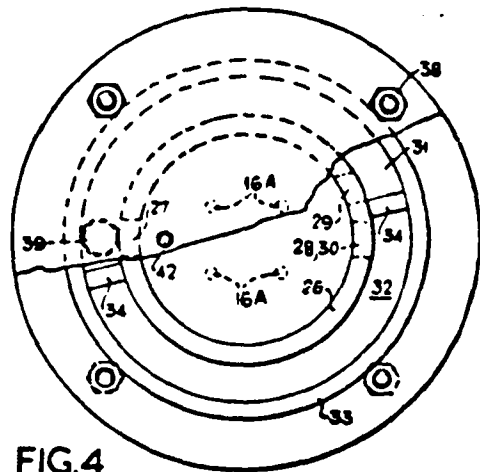

FIG. 4

Johnson Sea-cell.

The Johnson cell is a bipolar cell which is made of pvc tube, filled with wedge-shaped graphite or titanium segments.

See the drawing from the patent.

The distance between the electrodes is maintained at approximately 2 mm by means of "spacers". The spaces between the electrodes are connected by holes in the segments.

There is no information available on the processing.

The capacity can be regulated by the number of electrodes.

Supply: sea water of 3 % brine.

No water treatment.

#### 6.2.2.5 The Daika Engineering cell.<sup>44,51)</sup>

U.S. Pat. 3,766,045 (1973)

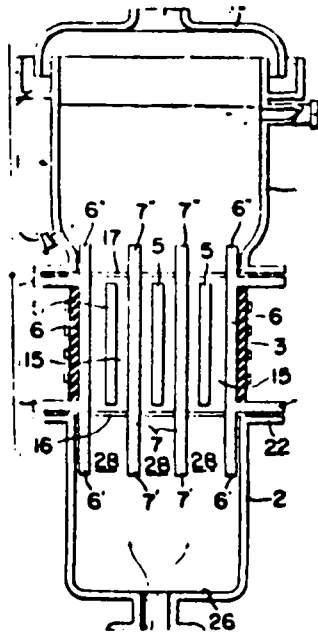

The construction of the D E cell is illustrated by the drawing from the patent (see above).

The distance between the electrodes is approximately 4 mm. The electrodes are not bipolar. Anodes: aluminium with titanium and then platinized.

Cathodes: steel (possibly chromium-plated)

Rate between the electrodes: 5 - 14 cm/s

Cell voltage: 3.7 - 5.1 V

Current efficiency: 72 - 76 %

Current density: 330 - 1330 A/m<sup>2</sup>

NaOCl prod.: 500 - 1900 g/h

Electrode size: 30 x 50 cm<sup>2</sup>.

6.2.2.6 Hypochlorite cell of the "Central Electricity Generating Board". <sup>50,51)</sup>

Adamson and others <sup>50)</sup> in their article describe the development of a bipolar, which led to the two prototypes I and II.

fig.21 from Adamson <sup>50)</sup>

(A) : Prototype II

(B) : Prototype I.

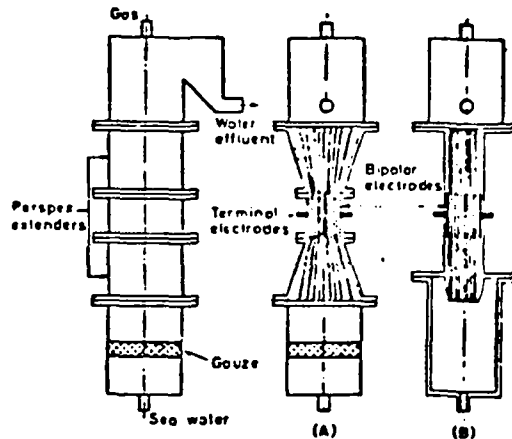

Electrodes: platinized titanium.

Use is made of high liquid velocities in order to prevent deposit on the electrodes. The construction resembles that of the Daika Engineering cell.

Further data for Prototype II:

Energy consumption: 5 - 7 kWh/kg NaOCl.

hypochlorite prod.: 0.3 to 0.7 kg/h.

NaOCl content: 0.15 %

electrode surface: 0.12 sq.ft.

For 10 bipoles, cell voltage 62.9 V at 200 A/sq.ft. and  
90.0 V at 450 A/sq.ft.

Other types and trade marks of cells, of which the operation is in principle the same, are:

- Chlorocell of Patterson Candy Int.

Brit.Pat. 1,080,918

1,080,756

1,080,919

U.S.Pat. 3,076,754

Ger. Offen. 1,102,709

-The Nora Sea Clor

-Cyclor, Cumberland Eng.Ltd.

Brit. Pat. 1,104,747.  
-IRD cell,<sup>51)</sup>

#### 6.2.2.7 Own development of a cell.

From the foregoing it appears that the various hypochlorite cells are variations of the same principle.

After some research it should be possible to develop a hypochlorite cell which is specifically suited for use in developing countries and bypasses the above patents.

Principles as described by Monastyrskii<sup>51)</sup> (see also 6.1.2) deserve special attention.

#### 6.2.2.8 Energy supply.

The power of the current supply of the equipment described earlier will not exceed 1 kW at a capacity of 0.5 kg NaOCl per day (usually in the neighbourhood of 200 W). This power can be supplied by any form of alternative energy.

Depending on the local conditions the following are to be considered:

- solar energy
- wind energy
- water energy
- gas engine stoked with wood, etc.

The required pump energy will also have to be obtained from the local energy supply. The power will depend on the type of cell chosen.

Usually it is necessary to construct the pumps for NaCl electrolysis in titanium. To prevent large investments use can be made of the "air lift" principle, for which only a system of compressed air is required.

Supply containers, tubes, etc. can be made of PVC or polypropylene.

## 7.0 Conclusions.

There are hypochlorite generators on the market that are suitable for the "in-situ" production of hypochlorite.

There are two categories:

- equipment with a high salt utilization and a high current efficiency, such as the Chloromat and the Cooper cell. They are less

suitable for application in developing countries because of the more or less complicated construction. At places where there is a certain degree of technological know-how available, the Cooper cell will be applicable.

- the hypochlorite cells, apparatus with a low salt utilization and low current efficiency. They have, however, the great advantage of a simple construction.

This type is probably more generally applicable, so that the hypochlorite cell will be central in the development of chlorination systems for developing countries.

Possibilities for research and development:

- A cell with a membrane of teflon as described in 6.2.1.4.
- A Batch system according to Griesheim (6.1.2.5)
- A cell according to the principle of Monastyrskii (6.1.2)
- A simple hypochlorite cell, which construction-wise bypasses all patents in this field, so that the cheapest possible cell can be produced.

8.0 Bibliography:

- 1) White G.C., Handbook of Chlorination. Van Nostrand Reinhold Co., New York.
- 2) Sconce J.C., Chlorine, Its Manufacture, Properties and Uses Reinhold Publishing Corp. New York, 1962.
- 3) Ibl N., Landolt D., Electrochim Acta 1970, 15, 1165
- 4) Stone R., J. AWWA. 1950, 42, 283.
- 5) Short note W.H.O. International reference center. Comm. water supply.
- 6) U.S. Patent 3,390,065 Cooper H.B.H.
- 7) Uhlmann, Verlag Chemie 1975, band 9, 335
- 8) Vaaler E., Trans. Electrochem. Soc. 1960, 107, 691.
- 10) Eur. Chem. News 1973, 24, (609), 16
- 11) Bianchi G., J. Appl. Electrochem. 1971, 1, 231-43
- 9) Hine F., Yasuda H., J. Electrochem. 1971, 118, 166.
- 12) Faita G., et al., J. Electrochem. 1970, 117, 1333.
- 13) Kuhn A.T., et al., J. Appl. Electrochem. 1972, 2, 283-87
- 14) De Nora O., Chem-Ing-Techn. 1970, 42, no.4, 222
- 15) ibid 1971, 43, no.4, 182
- 16) Horacek J., Duechaver S., Chem.Eng.Prog. 1971, 67(3), 71
- 17) Brit.Pat. 911425
- 18) Brit.Pat. 877901 (1957)  
885819 (1960)  
964913 (1961)
- 19) Brit.Pat. 885817 (1958)  
1076973 (1963)
- 20) Brit.Pat. 1,147,442 (1965)  
Belg.Pat. 710551.
- 21) J.Appl.Chem. 1969,19,298.
- 22) Kalinovskii E.A., Elektrokhiymya 1972,8,10,1468-71.
- 23) Hine F. et al, J. Electrochem. Soc. 1977,144,(4),500-05
- 24) Kuhn A.T., J. Electrochem. Soc. 1973,120(2),213
- 26) Antonov V.N., Khim.Prom-st. 1974,8,600-3
- 27) Fr. Demande 1,068,105 (1954)
- 28) Chem.-Ing.-Tech. 1972,44 (4),167
- 29) Chem.Zeitung 1976,100(5),234
- 30) Men'shakova N.I., Elektrokhiimiya 1973, (8), 1163-66
- 31) J. Am.Chem.Soc. 1968,90,3020.

- 32) Chem.-Ing.-Tech. 1972,44,(4), 158.
- 34) Chem.-Ing.-Tech. 1975,47,(14),617.
- 35) Dahl S.A. Chem.Eng. 1974,82(18),60.
- 37) Eur.Chem.News 1975,27(704),46.
- 36) Davis J.C. Chem.Eng.1975,18(18 Febr.),84.
- 38) Tjiok, Intern rapport 18-10-77.
- 39) Peters J.L. Trans. ASAE 1976,19(1),65-8
- 40) Michalek S.A., Leitz F.B.,J. WPCF 1972,44(9),1697
- 41) Fiedler R.P. J. AWWA. 1974, January, 46
- 42) Advertisement of Cloromat.
- 43) Nagy Z.J. Electrochem.soc. 1977,124(1),91
- 44) Adhia J.D. Chem.Age India.1976,27(7),634
- 45) Khodkevich S.D. Elektrokimiya 1977, 13(1),38-42
- 46) Bennett J.E. Chem.Eng.Progr. 1974,70(12), 60-3
- 47) Kuhn A. Processing 1975 March/April.
- 48) Khodkevich S.D. Elektrokimiya 1977,13(1),38-42
- 49) Skipchenko V.I. Sh. Prikl.Khim 1975,48(2),352-6
- 50) Adamson A.F.,J. Appl. Chem. 1963,13(11),483-95
- 51) Kuhn A.T., Chem.-Ing.-Tech. 1975,47(4),129
- 52) Jones D.L. Am. Dyest Rep.1972, August,28

## Appendix II. Survey of patents on ion-exchanger membranes.

U.S. Pat.	3,962,065	(76)	cell with Cl <sup>-</sup> permeable membrane	
			85: 101313	q
"	3,925,174	(75)	three-compartment cell	84:142640s
"	3,282,174	(73)	preparation of membrane	
Ger. Offen.	2,624,202	(76)	Electrolysis with KWM	1977 12:80914
"	2,644,443	(77)	KWM	1977 26:196965 m
"	2,638,791	(77)	fluor. KWM	1977 18:130044 d
"	2,624,694	(76)	Multi-electr cell with KWM	85:132871 z
"	2,607,242	(76)	KWM (Dupont)	1977 6:35761 b
"	2,624,202	(76)		KWM 12:80914 q
"	2,545,339	(76)	Bipolar cell with KWM	85:132869 e
"	2,546,205	(76)	fluor. membrane	85:132871 z
"	2,447,540	(75)	Preparation of KWM	83:132591 s
Jap. Kokai.	76 119383		fluor.KWM	1977 no. 10:62741 b
"	77 209980		KWM with numbers over R and A	1977 26:197962 h
"	77 18483		" "	26:196963j
"	77 241 75		" "	26:196964 k
"	77 23576		" "	24:179574 r
"	77 23575		" "	24:179575 s
"	77 23574		" "	24:179576 t
"	76 136579		" "	18:130034 a
"	76 134399		3-compartment cell KWM	18:130036 c
"	76 138597		" "	16:113014 b
"	76 110500		" "	14:98095 h
"	76 103099		" "	85:200139 u
"	75 81997		" "	83:139021 q
U.S. Pat.	3,770,567	(71)	} XR and Nafion membranes of Dupont	
"	3,884,885	(73)		
"	3,784,399	(71)		



## Appendix I: Survey of some patents on anodes between 1972 and 1977.

Jap. Kokai. 76133789 (1976) Ti electr. with Al, Cu etc.

CA 1977, 12:7613378 g

" 76116182 (1976) Ti + Pd,Ru,Ti oxides C.A.1977

26:196959 n

" 7407782 (1974) Anodes of Ti,Ta,Zr with Pt,Rh,Ru oxid.

81:44740

" 7342978 (1974) magnetite anode 80:86868

" 7463665 " " 82:23762 g

" 7319786 Ir, Rh on Ti with oxides 80:55386 h

Ger. Offen. 2,625,820 (76) PdO<sub>x</sub>, RuO<sub>x</sub>, SnO<sub>2</sub> on Ti,Ta,Zr

1977 14:98098 m

" 2,543,033 (76) Ti electr with oxide mixture of Ti,

Ru,Zr,Pt,Pd,Rh,Ir 85:101304 n

" 2,320,883 (73) Anodes A<sub>x</sub>Fe<sub>3-x</sub>O<sub>4</sub> (A=Mn,Ni,Co,Mg)

" 2,328,417 (74) Si anode with addition of B and P.

80:90415 t

" 2,035,212 (72) Ti anode 76:107314 b.

Belg. pat. 710551 Basic patent Ti with Ru and Ti oxides

U.S. Pat. 4,012,296 (77) Ti anode with Rh/Hf oxide, 1977 20:147851 n

" 4,007,107 (77) Pt<sub>3</sub>Mo anode with Ru<sub>3</sub>Mo<sub>5</sub>, PdTa, Pt<sub>3</sub>Ti

1977 16:113015

" 4,005,003 (77) Ti anode with layers of conductive and

corrosion-resistant oxide 1977 14:98106

" 3,963,593 (76) Pt<sub>3</sub>Si on graphite 85:

" 3,945,907 (76) Rhenium-coated cathodes 84:171517

" 3,617,462 (71) Pt(Ag,Au,Pd,Ir,Ru,)coated Ti Hydr.

electr. 76:67488 c

" 3,632,444 (72) graphite electrode impregn. with oil

76:80309 q

" 3,862,023 (75) Pt<sub>3</sub>Si on graphite 83:17747 k

Belg.Pat. 818,424 (73) Ti with RuO<sub>2</sub>,TiO<sub>2</sub> with a thin layer of

epoxy resin with Al,Fe,Cu powder