

Oxfam Water Supply Scheme for Emergencies

This equipment is part of several packages devised by the Oxfam Public Health Engineering Team to help provide a reliable water supply for populations affected by conflict or natural disaster. The equipment is designed to be used with any or all of the following Oxfam water equipment: Water Storage equipment, Water Coagulation and Disinfection equipment, Water Filtration equipment, Water Distribution equipment, Well Digging equipment, and Water Testing Kit. All are designed using available, easily transported equipment which is simple, rapidly assembled, and fully self-contained, to provide an adequate, safe water supply at moderate cost. The principles used in these packages may often be useful in long-term development projects.

The Oxfam equipment packages, which consist of “Oxfam” tanks (steel sheets, rubber liners), diesel water pumps, 3” PVC pipes etc, have been used successfully in the last two decades in often harsh environments, ranging from tropical to temperate climatic areas. Although this equipment is designed for emergencies, if installed and protected adequately it can give many years of useful service, though some up-grading works will be necessary to prolong its life. This equipment can be dismantled and re-used elsewhere.

However, these Oxfam equipment packages, while being simple to erect over a period of days, yet durable enough to last several years, do not lend themselves to very rapid deployment in a few hours. Increasingly, the nature of work which Oxfam has been called on to undertake has required equipment that can rapidly deployed then dismantled and moved to other locations. This has led to the development of the so called “rapid response kits” since the mid-1990s. This type of equipment is seen as a necessary complement to the original Oxfam equipment and is best used to provide a start up package in the absence of a detailed assessment and where affected populations are likely to be highly mobile. The relatively higher equipment costs and lack of suitability for anything other than short term water supply means that the deployment of the “rapid response kits” should be used only where appropriate.

Read this manual through before starting installation.

Contents

SECTION A - EQUIPMENT USE AND DESIGN	2
Determining pump output	2
SECTION B - LIST OF KITS AND INSTRUCTIONS FOR USE	7
Water pumping kits	7
Installation instructions	9
SECTION C - COMMISSIONING, OPERATION, SAFETY & MAINTENANCE INSTRUCTIONS	14
Commissioning	14
Operational problems	15
Maintenance	17
Safety precautions	22
SECTION D - DETAILS OF KITS AND SUPPLIERS	23
Full list of kit contents	23
List of suppliers	27
.	
Final reminders, recommendations and acknowledgements	

SECTION A - EQUIPMENT USE AND SYSTEM DESIGN

The Oxfam Water Pumping equipment is designed to be sufficiently versatile to provide pumps suitable for most emergency situations: for drawing water from surface sources; to provide the raw water for a potable water supply; to pump clean water from one area to another; or for loading and unloading water tankering trucks.

The Water Pumping equipment offers a range of three heavy-duty self-priming centrifugal pumps close-coupled to reliable and economical diesel engines: P2 for lower flows, P4 for high flows and P4H for high flows at higher heads. A lighter petrol driven pump, PR2 is also available for carrying on water trucks or other mobile uses. The individual pump curves are shown on page 3. The pump system curves are shown for the maximum performance available at full engine speed; ideally the pumps should be run at slightly lower speeds than this. Sufficient hoses and fittings are included to enable the pumps to be used either singly or in combinations for pumping water in a wide variety of situations. It is necessary to select the right number and combination of pumps for a given situation. These pumps are intended for immediate use in emergency situations. They are not necessarily the best solution for longer term pumping needs.

Although the suction pumps are intended primarily for pumping clean water, they will pump relatively turbid water with no problems in the short term. They are not, however, intended for use as trash or sludge pumps, and require some degree of protection from larger particles, (the strainers provided protect from particles larger than 10mm).

Each Oxfam pump kit contains a single pump, but it is strongly recommended that there are sufficient pumps immediately available on site to ensure continuing of the water supply during periods of breakdown, maintenance and repair. This is essential for the emergency situations for which they are primarily designed, where good maintenance facilities and the necessary skills and consumables are often unavailable. There should normally be one standby pump for each three service pumps, except for sites with few

pumps when a standby will be required for each pump.

Note: Persons responsible for the equipment covered in this manual must ensure that it is properly and safely installed and maintained and operated at the specified conditions. Only appropriately qualified staff, applying acceptable standards of engineering practice and the recommendations contained in this document, must be employed in these activities. Any similar instructions for the overall plant in which the equipment is to be incorporated, which have an influence on the equipment and application must also be followed. Statutory and local requirements concerning work practices, safety and / or health precautions must be observed.

Determining pump output

Pump performance or output (flow), measured by litres/second or m³/hr, will be determined by:

- Pump performance (varies from pump type; PR2, P2, P4, P4H) and speed of engine operation.
- Total pumping head consisting of static head and friction (head) losses in pipes.
- Suction lift.
- Engine derating to allow for operating conditions - temp, altitude and humidity

The four sections show a number of graphs and a brief explanation is provided to help assess how much water can be pumped in a particular situation.

Pump performance

The performance curves for each of the four pumps, PR2, P2, P4, P4H, are shown on page 3, and these show the variation of output with head for a range of engine speeds. To find out the actual output for any particular installation (i.e. pumps and pipes and where they are/will be laid) it is necessary to calculate the friction (head) losses within the system and measure the height to which the water will be delivered (static head). Head losses are calculated using the head loss diagram for uPVC and PE pipes provided in the Distribution manual. The pumping curves for pumps can then be used to read off the output (flow) at any given head for

each of the pumps and at given engine operating speeds. The engine are supplied with a variable speed control, movement of which will

give some change in pump output. Once adjusted to give an acceptable output this control should be locked to avoid tampering.

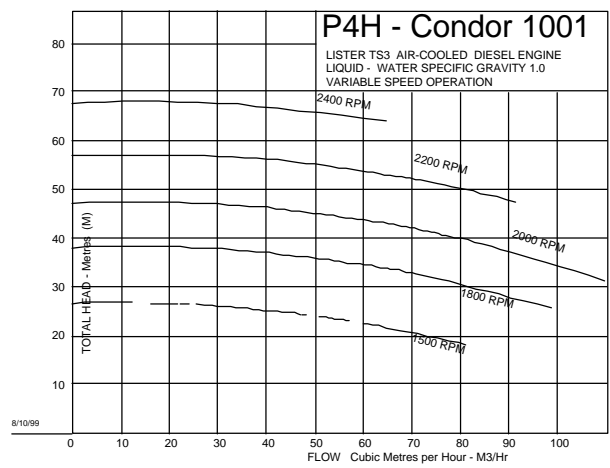
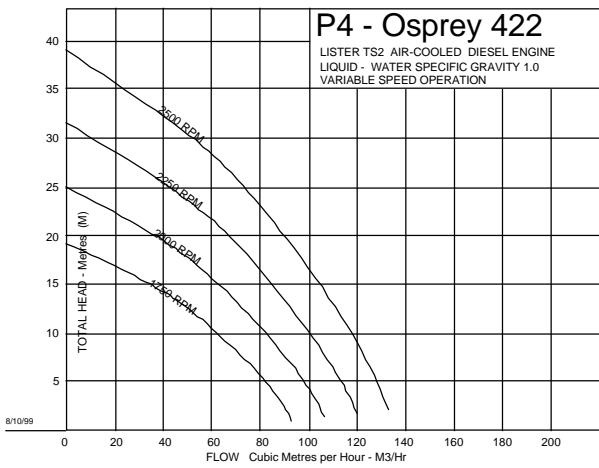
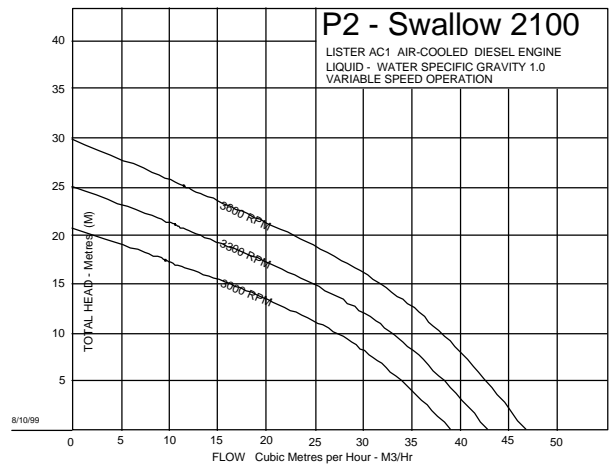
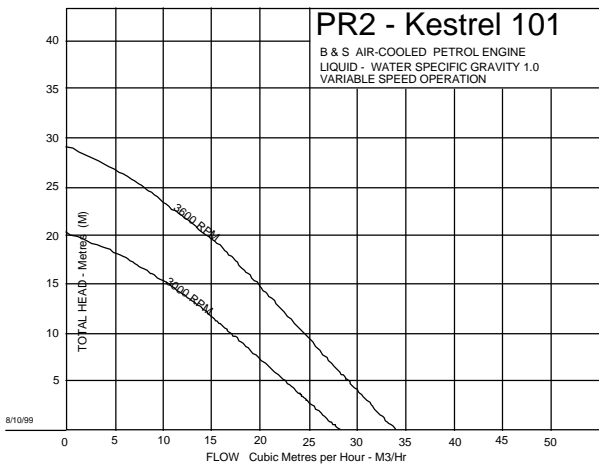

Pump system curves

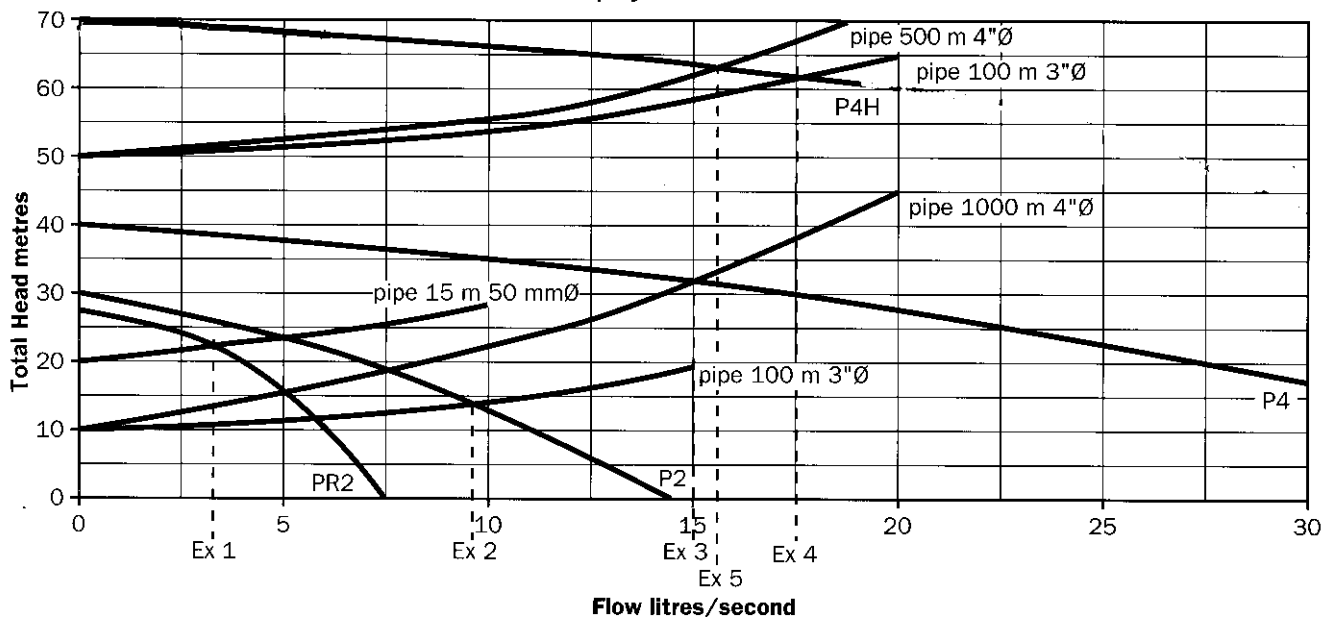

For direct comparison the curves for the 4 pumps have been superimposed on one graph above and also combined with system curves for particular lengths of pipe. Where the pump curve crosses the system curve for the particular installation, this defines the duty point and this gives the output expected from the pump.

Examples

Example 1. A PR2 pump will deliver 3.5 litres through 15 metres of 50mm Ø hose with a 20 metre lift (height difference) filling a T11 tank in 48 minutes.

Example 2. A P2 pump will deliver 9 l/s through 100 metres of 90mm Ø pipe with a 10 metre lift (height difference) filling a T45 tank in 83 minutes.

Example 3. A P4 pump will deliver 15 l/s through 1000 metres of 110mm Ø pipe with a 10 metre lift (height difference) filling a T45 tank in 50 minutes.

Examples 4 & 5. A P3H pump will deliver 17.5 l/s through 100 metres of 90mm Ø pipe or 15.5 litres/sec through 500 metres of 110mm Ø pipe with a 50 metre lift (height difference) filling a T45 tank in 43 or 48 minutes, respectively.

NB Pump curves shown are at 100 metres above sea level and 25°C.

1 bar = 10 metres head of water (approx.)

Where available pumps are inadequate due to lack of head or output, two or more pumps can be connected to increase their capacity to try to match system requirements. If two pumps of the same type are connected in series the pumping head is doubled, where they are connected in parallel the output is doubled. (When starting pumps in series, the pump nearest the water source should be started first.) The following curve illustrates the effect of placing two pumps in parallel, and also shows the effect of high suction heads for this particular pump. (Suction losses are discussed further in the following section.)

Note that the curves shown represent the pump performance at sea level and at the maximum engine speed. Prolonged and regular use at this speed is not recommended; some reduction in the performance shown is thus inevitable.

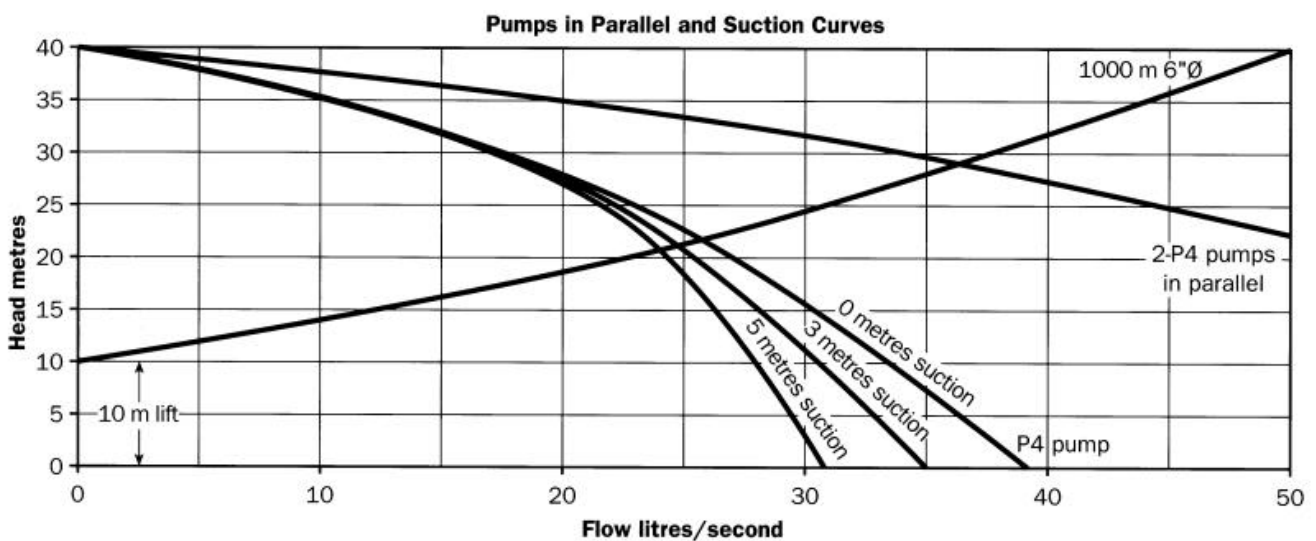

Total pumping head

This has to be taken into account by measuring the following;

- Elevation difference between pump intake water level and final discharge level.
- Head losses in pipes and fittings.

Example system curves are shown on the graphs on pages 3 & 4 which give outputs for particular pumps being used in particular situations.

Suction lift

Suction pumps of this type have a maximum suction lift of 7m. The practical and fuel efficient optimum should be considered as no more than 3m, which is usually possible when pumping from shallow wells or surface water sources. Use of higher than necessary suction lifts considerably reduce output and uses more fuel. The pump efficiency is reduced, both by suction lift (see curve on page 4) and losses in the suction hoses. Pumps should be located as close above the lowest expected water level as possible, but beware of mounting pumps too close to rivers which are prone to rapid flooding. It is often tempting to reduce the suction lift by sinking a pump into the ground. This should be avoided for all but shallow excavations as the exhaust fumes which collect in such confined spaces are very dangerous. The engine exhaust pipe should extend to the open air at all times.

The following figures (based upon use of Socla footvalves) and curves may be relevant in calculating the final performance

Flow rate in 10m of 3" pipework (l/s)	Dynamic suction head loss in 10m of 3" pipework (m)	Dynamic suction head loss in 10m of 4" pipework (m)
10	1.0	0.5
15	1.6	0.8
20	2.5	1.1
25	-	1.4

Where the pump cannot be located less than 7m above the lowest water level, then an alternative (shaft-driven, electrically powered submersible or compressed air powered) pump will be required, with all the increased complications that such installations entail. Oxfam stocks some of these pumps for such situations:

BPC – progressive cavity borehole pump kit. This is a progressive cavity fixed installation pump, often used for deep boreholes

BSP8, 12 or 16 – submersible pump kits driven by the electric motor in BSPE Submersible Borehole Pump Electric kit. This electric submersible pump kit is intended primarily for use in deep boreholes, though can be used in open wells where a shroud is used.

WPC – Dewatering kit (mobile air pump and compressor). The well dewatering pump is specifically for use in well digging operations for water removal during digging.

WSDP – Submersible Electrical Dewatering/desludging Pump Kit with Generator. This very versatile light-weight pumping kit has high solids and sludge handling capability, which means it can be used in a variety of situations such as cleaning open wells flooded with debris, desludging pit latrines and cleaning sediment out of water treatment tanks.

Engine de-rating

Altitude has a considerable effect on the efficiency of diesel engines, as do both high temperature and humidity.

At altitude a loss of output of approximately 6% per 500m elevation above sea level will result. In addition an output loss of 0.3% should be expected for every degree Centigrade above an ambient air temperature of 25°C, and for each 10% rise in humidity above zero a further loss of 0.4%-1.6% will occur. Thus use at 2500m at 35°C with 50% humidity would result in a 36% loss in power, which represents a similar drop in pump output - for example a reduction from 4 l/s to approximately 2.6 l/s when pumping against 20m head. Use the curves on page 6 to estimate the reduced output for a given location.

De-rating of naturally aspirated diesel and petrol engines

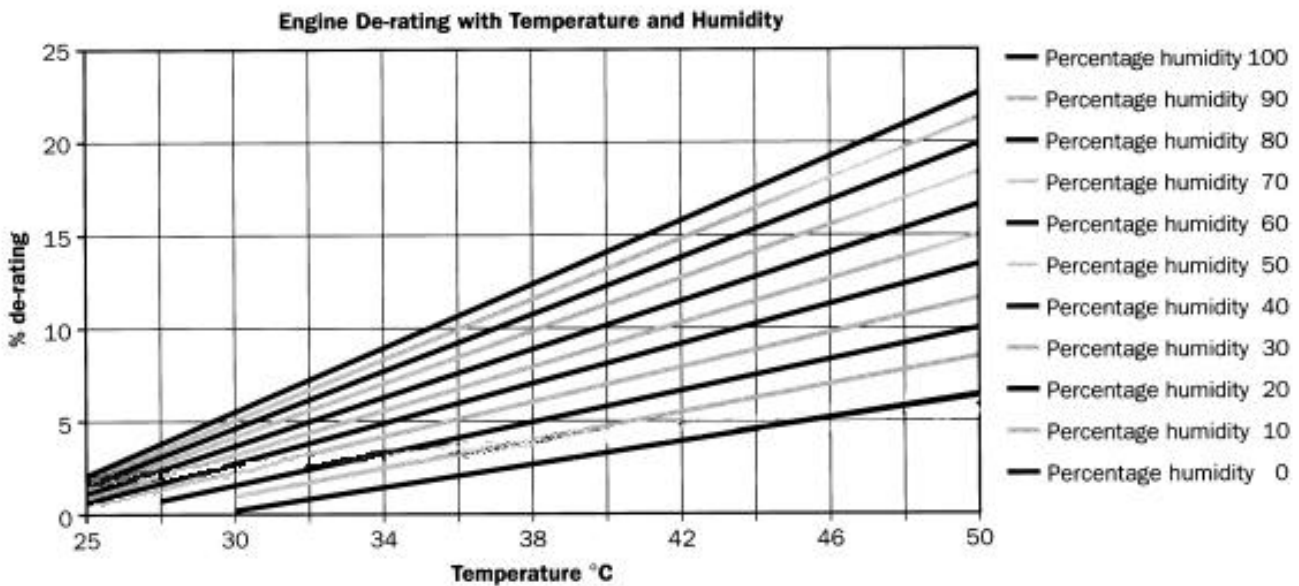
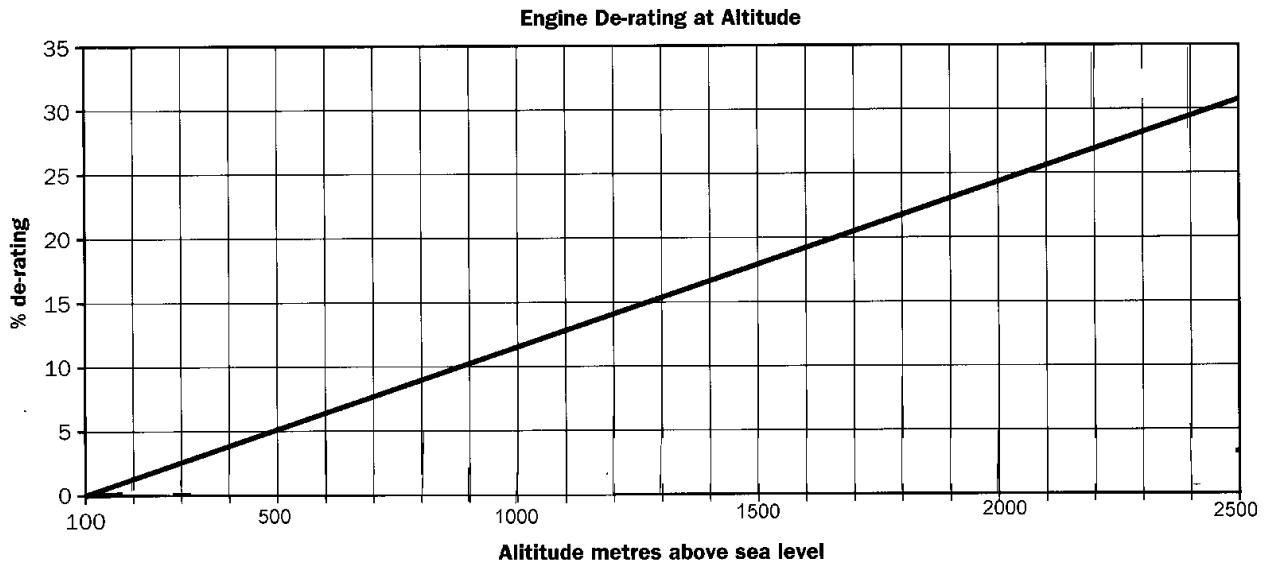

Diesel and petrol engines have similar de-rating requirements. Where petrol engines are overloaded due to high altitude, humidity or temperature, they will simply run at lower engine speeds and deliver less water. Diesel engines will struggle more to maintain a speed when under the de-rating effects of altitude, humidity and/or temperature (Symptoms:- black smoke heavy with particulates from the exhaust and overheating around the manifold and cylinder head). THE CURE - Lower engine speed by adjusting governor setting until these overload symptoms disappear. It is a characteristic of a centrifugal pump that the lower the speed, the less power is absorbed. Note: these graphs apply to naturally aspirated engines, Turbocharged engines (which are not normally used by Oxfam) have different derating requirements.

SECTION B - LIST OF KITS AND INSTRUCTIONS FOR USE

Water pumping kits

Each of the Pump Kits contains all the fittings and hoses necessary for installation in most situations and this is standardised to 3" for discharge pipework for the P2, P4 and P4H pumps. For optimum performance, the P2 pump design is based on using 2" suction/delivery pipework, although for simplicity 3" suction/discharge pipework is used. (4" suction hose is provided with the P4 and P4H.) All pumps are now provided with oil as part of the kit, though only limited quantities are provided for the P2, P4 and P4H pump engines and it will be necessary to order further quantities of the correct oil separately (Code PO except for low temperature locations). The Pump Fittings Kits (Code PF) provides additional fittings to allow pumps to be connected in parallel (see below). Tools for initial installation are provided in the Site Tool Kit (Code OS). Comprehensive tool kits are also available – Kits OE (Engineers) and OM (Mechanics).

The Pump Kits include sets of consumables and essential spares for minimum 1 year operation (2000 hours at 5 to 6 hours per day for one year) and maintenance of both the engine and the pump, based on operation in fairly unfavorable/dusty site conditions with minimal maintenance support/service. This period can be extended if site conditions are more favorable. The lightweight pump has spares for

500 hours. Experience has shown that it is unnecessary to order a Major Repair or Overhaul Kit for every pumpset supplied. On sites where a number of pumps are to be deployed, it is suggested that initially one Overhaul Kit be ordered for every 5 or more pumps supplied. Ultimately, the appropriate quantity of overhaul or specific spares to be ordered has to be judged against the actual need and the site conditions such as competence of mechanics, workshop facilities, maintenance and repair practices, duration of project, etc. The optional 6,000-hour Overhaul Kits for the Lister engines are coded PE2-LI PE4-LI and PE4H-LI. In cases where major damages occur (e.g. cracked casing) it may be more appropriate to replace than to repair the pump. The optional major repair/Overhaul Kit for the pumps are now coded PS2-AL, PS4-AL, PS4H-PS. Oxfam prefers to stock and supply pumps powered with Lister engines and these should be considered as the Oxfam standard. However in some instances it may be more appropriate and necessary for Oxfam to supply pumps powered with Lombardini engines. For this reason, pumps powered with both engine types are used, though normally pumps driven by Lister engines will be provided and only these are listed below.

This manual explains how to install and use the following kits (detailed kit lists are provided in section D):

Code	Description
P2-ALLI	2" Atalanta Swallow 2100/Lister AC1 Diesel Pumpset Kit, with Hose
PE2-LI	Lister AC1 Engine Overhaul Kit
PS2-AL	2" Atalanta Swallow 2100 Pump Major Repair Kit
P4-ALLI	4" Osprey 422 Atalanta Pumpset Kit, Lister TS2 Engine and Hose
PE4-LI	Lister TS2 Engine Overhaul Kit with agglomerator, 6000 hours
PS4-AL	4" Atalanta Osprey 422/452 Pump Major Repair Kit
P4H-PSLI	4" Atalanta Condor 1001 Pumpset Kit, Lister TS3 Engine and Hose
PE4H-L1	Lister TS3 Engine Overhaul Kit with agglomerator (6000 hours)
PS4H-PS	4" Atalanta Condor 1001 Pump Major Repair Kit
PR2-ALBS	2" Pump Sets Kestrel 101/Briggs and Stratton, Petrol, Lightweight Pumpset Kit
PF	Pumping Pack Fittings for pumps in parallel or pumping into distribution
PO	Pumping Pack Oil
OE	Engineers Tool Kit (mason/carpenter/building)
OM	Mechanics Tool Kit (for vehicle and engine maintenance)
OS	Site Tool Kit for initial installation requirements

The range of Oxfam pump kits



PR2 kit



P2 kit



P4 kit



P4H kit

Installation instructions

Pumping from a water source to storage

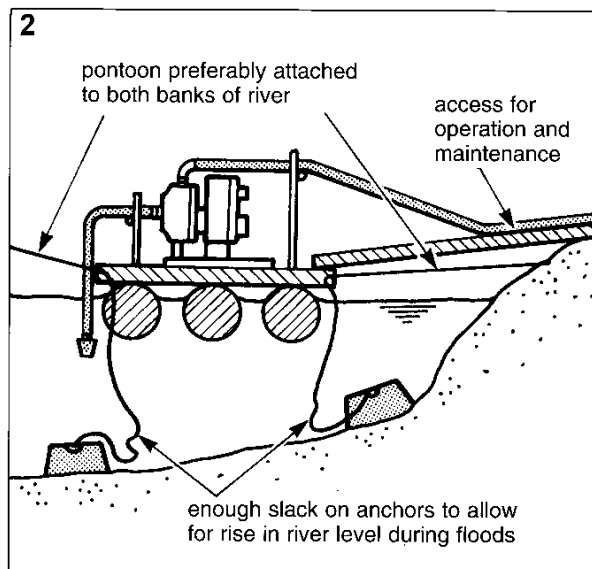
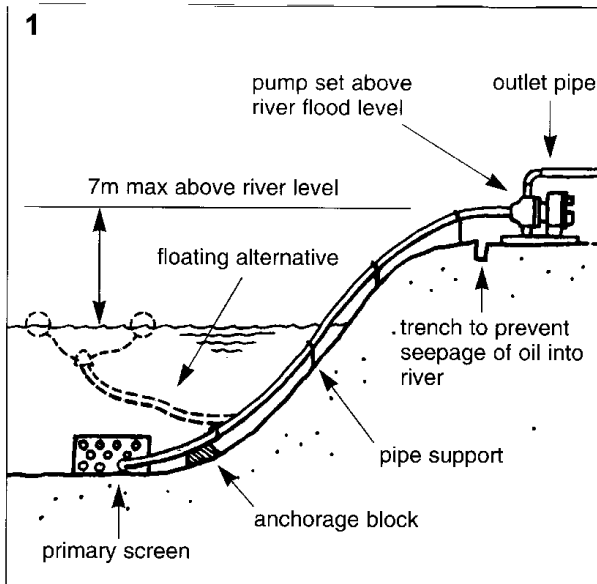

1. At the start of an emergency response, there may be no alternative other than to use a surface water source directly. In such cases it is inevitable that the water will be contaminated and some form of treatment will be necessary, either by simple chlorination alone or combined with settlement which may be followed by filtration. Water may be pumped directly from rivers or lakes with the coarse strainer set on the bed, provided that a primary screen is improvised, for example by use of a gravel-filled, perforated drum, to avoid inflow of sand, silt, weeds and leaves, which could damage the pump and make treatment more difficult. A perforated drum may be covered with filter fabric, code FX. Silt intake can be reduced by floating the intake clear of the bed of the river, suspended no less than 0.3m below the surface (any less and vortices may form), anchored against strong currents. The pump must be set above the river flood level or provision made for it to be raised/lowered or slid as necessary to keep it above the river level, while keeping the length of suction hose as short as possible (see 6. Below).

2. An alternative is to mount the pump on a pontoon. This is difficult to operate but does have the advantage of uniform, low suction head. The pontoon must be securely anchored. Fixings must be sufficiently strong to resist sudden floods and anchor ropes long enough to allow for rises and falls in level. Continuous movement of the pontoon gives rise to flexing and movement of the delivery hose which can lead to connections becoming loose and damage to the hose. Alternatively the pump could be mounted on a fixed platform above the water.

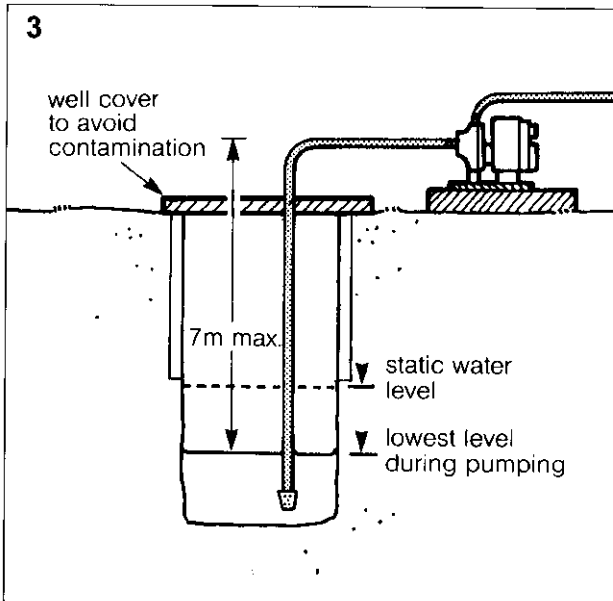

3. It is always preferable to exploit ground water sources, as these are naturally better protected from contamination than surface sources. The pumps can only be readily used for ground water sources where the water level will not drop below 7m from the surface when pumping. The static water level, when pumping is not taking place, will be above this. The pump should be fixed a small distance from the well to help prevent contamination of the water by fuel and oil spillage and to maintain the stability of the well. The strainer should be suspended just above the bottom of the well in order to avoid sucking sand. The foot-valve provided has an external diameter of 80mm (P2) and 100mm (P4H & P4), and can be used in shallow, cased tubewells just greater than these diameters.

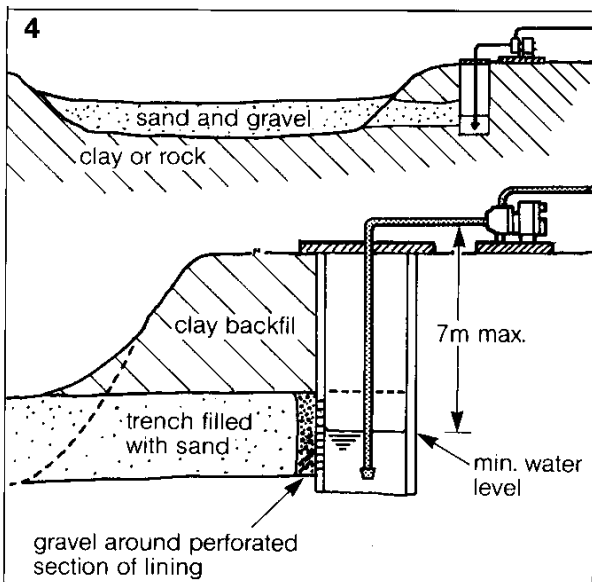

4. If no groundwater source is immediately available a good alternative is the exploitation of a surface water source by filtration through bed sediments. This can be done, as shown here, by constructing a well in the bank of the stream and making sure that this is connected to the stream bed by a continuous sand layer. This method may yield water even when there is none evident on the stream surface, as much is stored in the bed sediments.

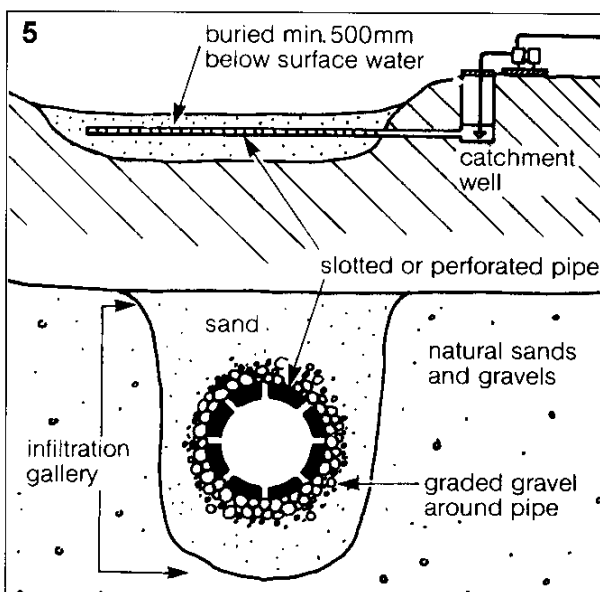

5. In order to improve flows from surface and subsurface sources use may be made of an infiltration gallery. A perforated pipe is buried in the riverbed, surrounded by graded gravel and sand and connected to a collection chamber in the stream bank from which the water is pumped. The yield may be increased by construction of a subsurface dam, a wall across the riverbed, which blocks the subsurface flow. The dam would be located down-stream from the infiltration gallery.

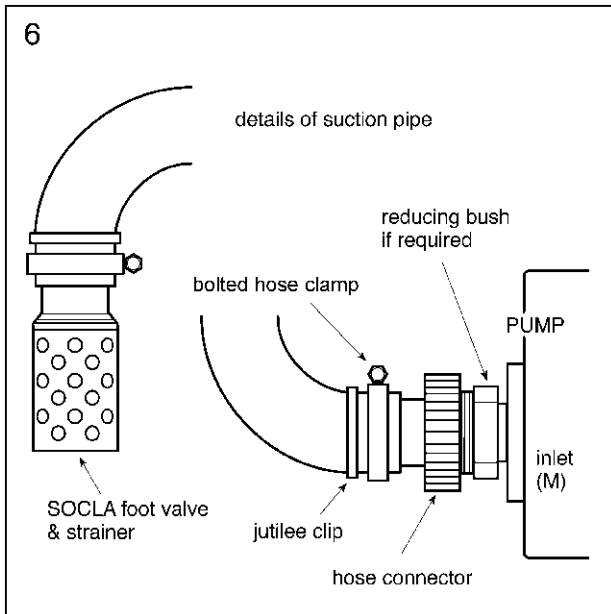

6. Pumps are supplied with foot-valves and coarse strainers and 10m lengths (PR2 has 6m) of reinforced flexible suction hose. The length should be kept as short as possible in order to increase efficiency. For optimum performance the P4 and P4H pump design is based on using 4" suction pipework, and this hose should be used. However if the pump has to be sited more than 10m from the source, then a longer length of pipe than is available with the kit will be required and 3" fittings are provided so a longer length of the more commonly used 3" pipe can be fitted. However reduction in size in the suction pipework will result in significant drop in pump performance. Cut hose with a hacksaw, as square as possible to aid fitting to connectors. Push the hose fully onto the connector (using pipe grease as a lubricant) and fit the clip close to the end of the hose. It is important that the washer supplied is used with female hose couplers and that PTFE tape is used to seal all threaded joints. All joints on the suction side of the pump must be completely airtight, otherwise the pump will not operate and this is why a jubilee clip is supplied in addition to the bolted hose clamp, which on its own will not provide an airtight seal.

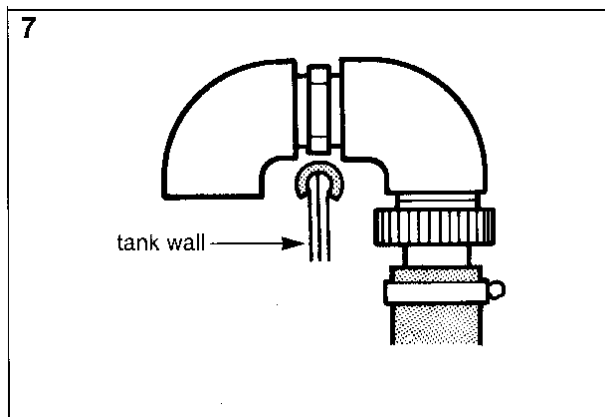

7. The delivery connection to the storage tank may be made entirely using flexible hose, or by connecting to a rigid pipeline. If connecting to an Oxfam storage tank the inlet may be made by using the standard 3" flange connector assembly, to which the hose may be coupled directly, or, as shown here, by passing over the rim of the tank.

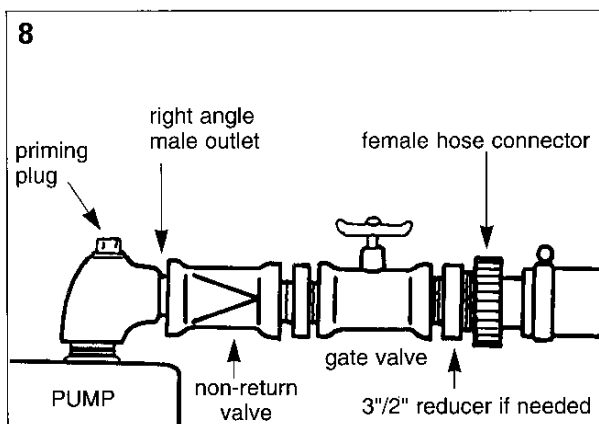

8. A gate valve is provided to act as a throttle if it is wished to reduce the pump yield because of insufficient inflow to the water source. This valve will also aid in priming the pump if it is closed after pump operation and opened after restarting. Pumping against a fully closed valve must be avoided, other than for pump starting and stopping. A non-return valve must be included to reduce back flow through the pump especially if two pumps are working in parallel.

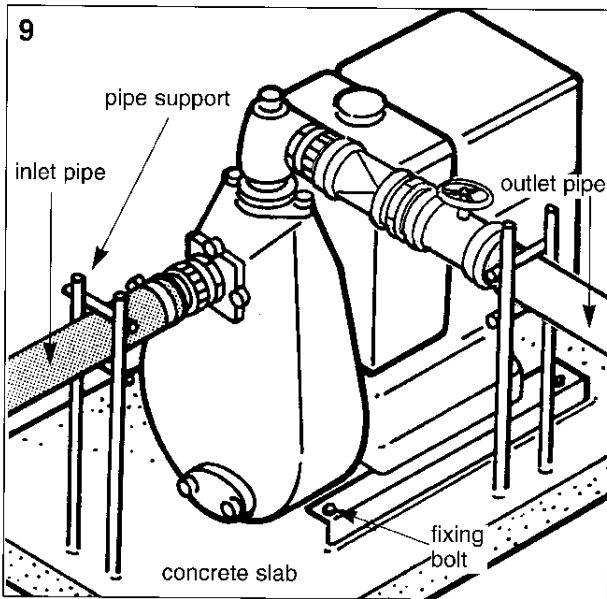

9. It is very important that the pump is securely fixed to the ground. The pump may be bolted to heavy timber, which is pegged to the ground. The packing case bottom sections are designed as temporary foundations and can be used initially for a short-term solution. Within a few weeks more substantial foundations should be provided. For the different pumps with their different weights this would require the following sizes of concrete slab: P2 1.1 x 0.8 x 0.15m; P4 1.5 x 1.0 x 0.2m; P4H 1.8 x 1.3 x 0.25m. The anchor bolts supplied with the pump should be cast into the slab, using a wooden template to simulate the pump skid to ensure they are fixed at the right centres and preferably with the bolts welded to steel reinforcing bars. Once the concrete has properly cured the pump can be positioned and tightened onto the slab. The inlet and outlet houses should be supported close to the pump in order to prevent damage to the connections through vibration. These supports should be put into place as soon as possible unless the installation is temporary.

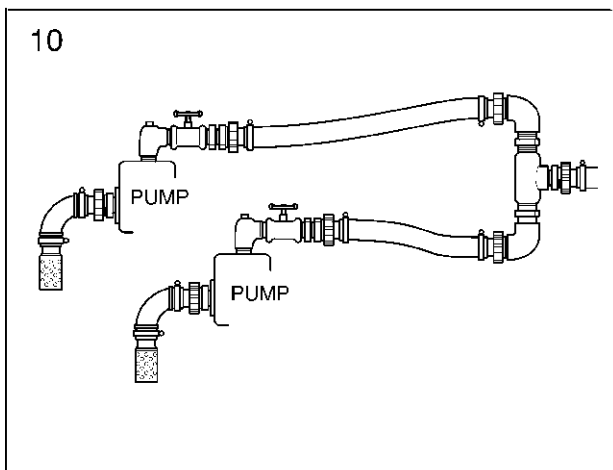

10. This arrangement allows one pump to be used as duty pump and the other as stand-by. It also allows doubling of flow rate when both are pumping simultaneously. The fittings provided in the pump fittings kit (Code PF) can be used and the kit should only be ordered for this purpose (or as in 11 below), as the standard range of fittings included in the pump kits is sufficient for most uses illustrated in the Pumping Pack Manual.

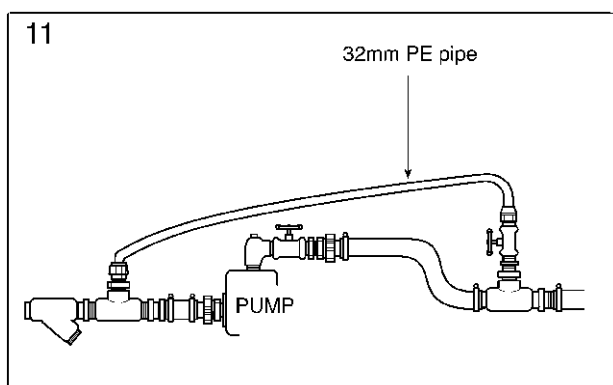

11. Where required, pumps can be used for pumping directly into distribution network if the site is flat and distribution mains run long distances. It is recommended that either a P2 or P4 be used for this, the actual selection made on the basis of pump availability and more importantly on correct sizing using the design principles outlined in Section A. The connection into a 3" distribution network is made with a 32mm MDPE pressure-relief bypass pipe (not provided in this kit). The fittings provided in the pump fittings kit (Code PF) can be used for this and the kit should only be ordered for this purpose (or as in 10 above).

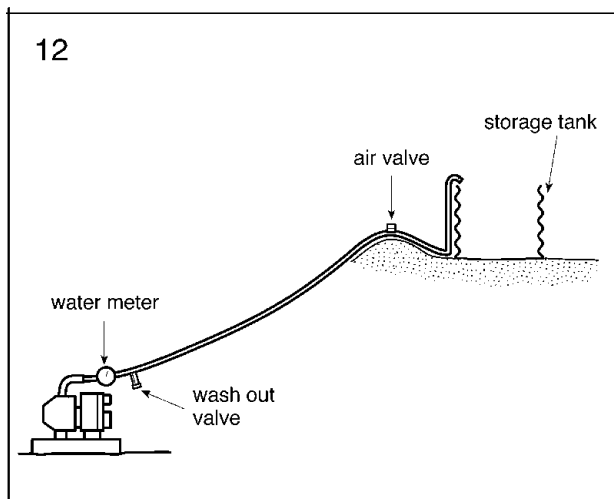

12. The design of any pumping main should take into consideration the following points over and above the basic system design outlined in Section A. (a) Avoid creating peaks in pipelines, which can cause air to become trapped, unless air valves are fitted. (b) You may need to include washout branches and valves where pumped water is dirty. (c) Water meters may be helpful for pumped water quantity measurement. (d) Be aware of the effects of water hammer especially for the P4 and P4H pumps (see below).

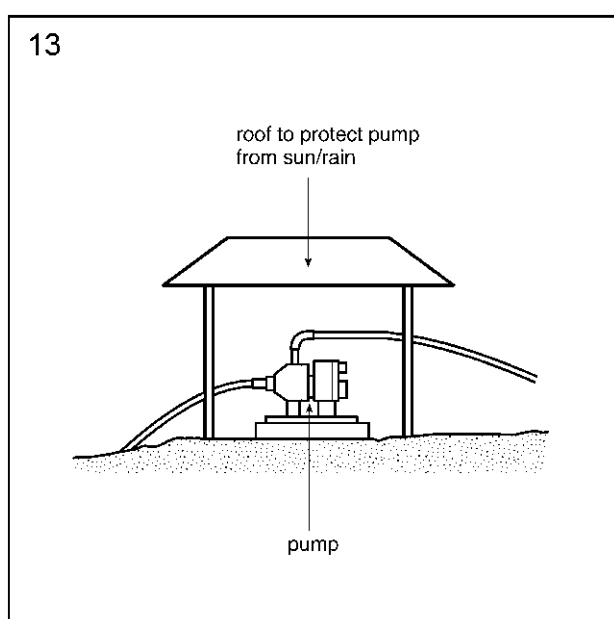

13. Where pump installations are likely to be used for more than a couple of weeks, a suitable roof should be provided to protect the pump from the effects of rain and sunlight. A simple shelter of plastic sheeting offers the quickest solution and may be adequate in all but snowy or very windy conditions. Where the pump house is to be provided with walls, adequate arrangements must be made for venting exhaust fumes outside of the building. The pump house should be large enough to provide good access for the pump operator and strong enough to provide security where this is an issue.

Maximum pressure fluctuation above and below dynamic pressure on instantaneous valve closure or power failure.

Pipe material	pressure fall/rise per metre per second of velocity in pipe in metres head	e.g when velocity is 2 m/s pressure change in metres head
MDPE	25	50
PVC	53	106
steel	134	268

These values will be greatly reduced when using diesel engines as the inertia of the engine will slow the effective rate of closure.

Surge/water hammer

Serious changes in pressure occur when there is a sudden change of flow in a pipe. This is most often observed when electric pumps stop due to power failure or sudden trips caused by level controls. The approximate maximum theoretical values are shown in the table. If these values are likely to cause excessive over pressure or vacuum conditions, then a detailed computer analysis should be commissioned. Pipes can normally sustain twice their rated working pressure for such transient conditions.

SECTION C - COMMISSIONING, OPERATION, MAINTENANCE AND SAFETY INFORMATION

Commissioning

Follow maker's instructions, shown in the engine manual (enclosed with the kit) for commissioning the engine before attempting to start. The lead acid batteries are normally supplied fully charged but dry. Before use fill cells with dilute sulphuric acid (specific gravity 1.23 in tropical countries, 1.28 elsewhere). Fill the engine sump with clean oil of the recommended grade. After completing the installation, including fixing the pump securely and supporting the suction and delivery hoses, ensure that the suction hose is well submersed in water. Fill the suction hose with water and prime the pump by filling with water through the priming hole in the pump outlet. Close the discharge valve (though the pump can be started against a closed discharge valve, this should only be permitted for a short time, as operating it against a closed head for more than 5-10 minutes will risks damage to the pump or a steam explosion). Pump the water produced in the first few seconds to waste to flush out any debris and traces of oil/rust inhibitor.

If the pump does not operate within five minutes from first starting the engine re-check that all pipe joints on the suction side are airtight as any air in the hose will prevent satisfactory pump operation.

When the pump is operating adjust the yield to suit both demand and the supply available at the source. Minor adjustments may be achieved by changing the engine speed, but if this gives insufficient reduction use a throttle valve on the delivery side of the pump to introduce an artificial increase in head. After making such adjustments, lock the speed control and remove the hand wheel of the valve to make sure they cannot be tampered with.

Bury hoses and pipes wherever possible in order to reduce damage. Shading is particularly important in hot climates as high temperatures reduce engine efficiency. Ensure that both initial and regular maintenance of the pump and engine is carried out by a competent mechanic,

according to makers' instructions. Regular replacement of oil, fuel and air filter elements is essential, as is changing of engine oil. Check the level of engine oil every day, or more frequently if running for prolonged periods. Keep the engine running at the recommended speed and ensure that fuel used is of good quality. Use the filter funnel provided when filling the tank.

Fuel consumption should range from 1.1 litres/hour for the PR2 and P2 pumps to 3.6 litres/hour (P4) and 4.6 litres/hour (P3H) at 75% full load at lower altitudes.

The following lists the sequence of operations and checks to be made in order to start the engine:

Starting any diesel engine can be dangerous in the hands of an inexperienced person. Before starting, the operator must understand the engine controls and have been instructed in the correct starting procedures:

- Ensure the engine is free to turn without obstruction.
- Check that the fuel and lubrication oil levels are correct.
- Ensure the fuel system is primed.
- Move the decompressor lever(s) towards stop and hold in this position.
- Move the engine control to the RUN position.
- If a variable speed control is fitted: move the speed control lever towards the fast position.
- Crank the engine really fast. When sufficient speed is obtained move the decompressor lever down and continue to crank until the engine fires, retaining a firm grip on the starting handle. Remove the handle from the engine.
- Where a speed control is fitted, reduce the speed as required.
- To stop the engine, close the discharge valve and move the engine control to STOP and wait until the engine comes to rest.

Warning: Never stop the engine by using the decompressor lever. Valve damage may occur

Operational problems

The most common problems occur on the suction side of the pump. The most likely causes are lack of pump prime or blockages. Lack of prime is due to air getting into the suction hose, which may be caused either by leaking joints or by lack of water at the source. All pipe joints should be regularly checked but beware of over-tightening plastic fittings. If the source is being pumped dry adjust either the pump yield or the daily pumping periods. Check regularly that the foot-valve is operating satisfactorily and is not being blocked open by sand and gravel. Cavitation damage can be caused to the pump by running with air being sucked in.

Blockages may occur at the suction strainer due to sand and silt when pumping from the bottom of a well or river. Either build better screening protection around the strainer or suspend it above the bottom. When pumping from a river the strainer may become blocked by vegetation. This can be avoided by use of a screen combined with regular cleaning. Beware of completely emptying tankers and running pumps dry. This can cause serious damage to the impellers.

Ensure that the engine fuel tank is kept regularly topped up with clean fuel. If a diesel engine runs out of fuel it will be necessary to bleed the fuel system of air. The standard fuel tanks should provide enough fuel for 3-4 hours running.

Fault checklist

Special Note: Most pump problems are caused by leaks in the suction line and fittings

Pump does not prime or retain prime after operating

1. Ensure pump is full of liquid.
2. Check suction line for leaks, air locks and collapse.*
3. Check discharge line for obstruction and open valves.

4. Check pump and prime mover are operating at correct speed (shown on pump rating plate)
5. Ensure that maximum static lift is less than 7m and length of suction line out of the pumping liquid is less than 10m to keep suction head losses low
6. Check for clogged or worn impeller, or wear ring
7. If all the above have been eliminated suspect

Note: As the non-return valves have metal-to-metal contact they do not provide a watertight seal and where there is a high static head in the system and the pumps are turned off at night the following situation can develop. Water gradually leaks back through the check valve and the pumps into the suction hose, where it can go no further due to the footvalve. Then the pressure in the suction hose (which has a low-pressure rating) builds up until it reaches the static pressure in the system, up to 60m with a P4H and the suction pipe starts to leak. Closure of the discharge valve after turning the pump off will prevent this situation occurring. a mechanical seal failure

Pump primes but does not deliver rated capacity

Check 1 to 7 above

1. Check static height and resistance between inlet of suction line and outlet of discharge line. Ensure that total system head is not greater than rated head
2. Engine speed too low
3. Outlet valve partially closed

Pump uses too much power

1. Check for debris in pump
2. Coupling out of alignment
3. Speed too high
4. Impeller or bearings are binding

Note: If engine is operating in conditions much above 25°C and/or 100m above sea level, it will lose power and may become overloaded (symptoms: black exhaust emission and labouring). To reduce load reduce speed below that indicated on rating plate and/or reduce output by partially closing a valve on the pump discharge.

Liquid drips where shaft enters the pump casing

1. Damaged mechanical seal

Pump makes an excessive noise

1. Cavitation in pump because suction lift is too high or restricted
2. Pump not secured to firm foundation
3. Restricted suction line

Failure to prime pump

This diagram shows some of the reasons why a pump may fail.

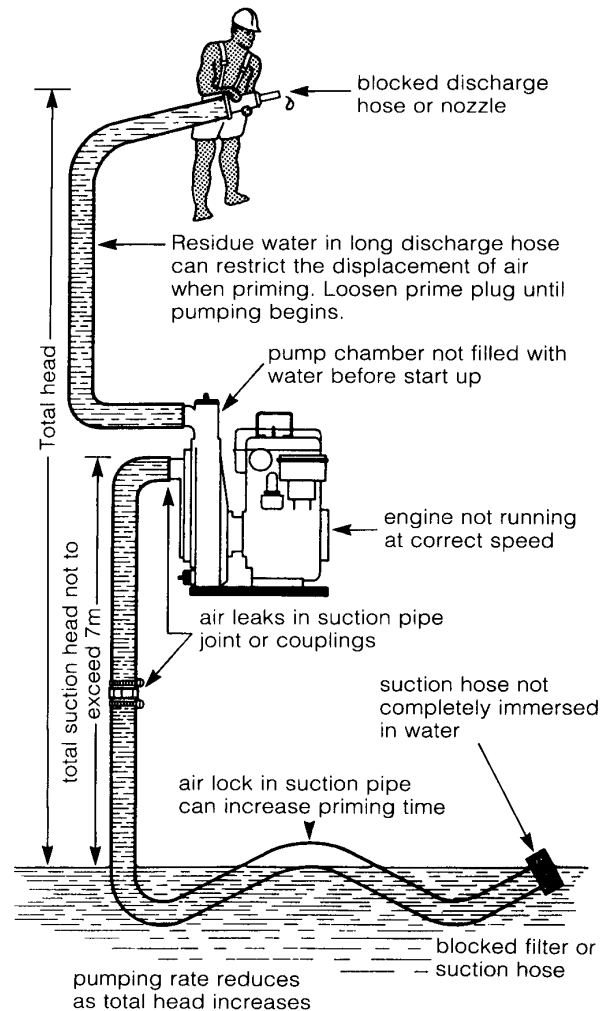

Maintenance

- Wear protective overalls, and keep items of loose clothing clear of all hot and moving parts. Use protective barrier cream when necessary.
- Whenever possible clean components and the surrounding area before they are removed or dismantled.
- Service Tools are designed to aid the dismantling and assembly procedures and their use will prevent unnecessary damage to components. It is recommended that Service Tools are always used: some operations cannot be safely carried out without the aid of the relevant tool.
- Decarbonising the engine is usually carried out at 2000 hours unless the engine shows signs of loss of compression.
- When re-assembling an engine it is always advisable to apply a small quantity of new lubricating oil to all moving parts.
- Take particular care to exclude all dirt and debris from the fuel injection equipment while it is being serviced.
- Take extreme care to exclude dirt from all jointing surfaces and keep jointing compound away from all tapped holes unless otherwise specified.
- It is recommended that all oil seals are replaced once they have been removed from their original position. Seals must be fitted square in the housing and all lip seals must be fitted with the lip facing the lubricant to be retained. A service tool should be used to install seals and care must be taken to prevent damaging the new seal when it passes over shafts.
- Before fitting a new oil seal it is important that the recess in the seal is filled with Shell Alvania R2 Grease; this is a Lithium Grease to NLG1 No 2 consistency. Alternatively immerse the seal in engine lubricating oil at ambient temperature for 24 hours.
- When re-assembling an engine it is always advisable to renew gaskets, washers and nuts and bolts that have been taken from high stress locations, in particular nuts and/or bolts from connecting rods and cylinder heads should be renewed.
- All nuts, bolts, setscrews and studs with damaged threads must always be replaced.

Using a tap or die to repair damaged threads may impair the strength and closeness of fit of the threads and is not recommended. Do not allow grease or oil to enter a blind threaded hole as the hydraulic action present when the bolt or stud is screwed in could split or stress the housing.

- To check or re-torque a bolt or nut, it should be slackened a quarter of a turn and then re-tightened to the specified value.
- On nuts with identification marked on one face the frictional area of that surface will be reduced therefore the nut should be fitted with the unmarked face towards the component.
- It is sound engineering practice to tighten bolts or nuts holding cylinder heads, sumps, covers and doors diagonally. This will ensure the component is pulled down square, resulting in less chance of oil seepage from the joint.
- After any maintenance work on the engine has been completed, the lubricating oil and fuel levels must be checked and all safety guards replaced before starting.
- **Warning: Damage will be caused to the flywheel fan if it is used to turn the crankshaft.**

Lubricating Oil Specification for Pump Engines - Lister-Petter & Briggs and Stratton

1. These engines must be run on heavy duty lubricating oils meeting the requirements of AP1 CC, MIL-L-46152A/B, MIL-L-2104B or DEF2101 D. Straight mineral oils are not suitable, neither are oils of less detergency than specified. Generally a multi-grade 15W/40 as supplied in the Pumping Pack Oil Kit Code PO will be suitable for all engines except where ambient temperatures consistently fall below freezing when a lower grade should be used.

2. API CD, MIL-L-21 04C/D or Series 3 oils can inhibit the running-in process in new or reconditioned engines. They are not suitable for engines running on low duty cycles, but can be recommended for engines running at a high load factor, particularly in conjunction with high ambient temperatures, after the first oil change. (They must also be used if the sulphur content of the fuel exceeds 0.5%.)

3. The Briggs and Stratton engine uses a high quality detergent oil, classified for service SE/SF/SG, specifically a SAE 30 oil. Air-cooled engines run hotter than automotive engines, and the use of a multi-viscosity (grade) oil will result in high oil consumption and possible engine damage. If the use of multi-grade oils is necessary, the oil levels should be checked more regularly.

Storage of pumps

If the pump set is to be taken out of service for a long period of time carry out the following procedures:

- Drain all the liquid from the pump
- Clean and dry all components which have come in contact with liquid
- Spray the internal parts of the body especially around the impeller with light penetration oil such as WD40 or, if this is not available, flush body with diesel oil.

- Grease the thread of the suction and discharge ports (openings) and tape off to keep dirt out of the pump body.
- Store in a clean dry location away from vibration.
- Turn the pump once every 30 days to prevent binding of the bearings and seal face sticking.

All of these pumps are designed for reuse and thus can be dismantled and packed away for further use as required. However, particularly with the Oxfam pumps, which have numerous components and some consumable materials such as PTFE tape, dismantling and re-boxing will have to be conducted with care. All items should be checked back into boxes and ticked off against the original packing list and items replaced as required to make up a complete kit.

Routine maintenance schedule

CODE P2, P4H and P4 pumps and engines

First 25 hours	1. Check and adjust, if necessary, tappet clearances. Tighten nuts, bolts and unions, especially the fuel system. Change oil.
Daily	2. Check supply of fuel oil, watch for dirty exhaust – overload or faulty injectors. 3. With the engine stopped, check level and condition of lubricating oil. 4. Clean the air cleaner if being used under very dusty conditions. 5. Check clack valve on pump body, flush and fill with clean water. NB: If there is any chance of frost water should be drained immediately after use. 6. Check and clean suction hose filter/foot valve if fitted.
Weekly	7. Check for mechanical seal leaks, hoses for damage, excessive noise or vibration, all bolts for tightness and security of couplings.
125 hours	8. Clean or change the air cleaner element if being used under moderately dusty conditions. 9. Check for fuel and lubrication oil leaks, tightening nuts and fittings as necessary.
250 hours	10. Drain lubricating oil. Flush out system, renew filter element and refill with correct type and grade of oil. 11. Clean the fuel injector nozzles if the exhaust is dirty. Renew fuel filter element if the fuel is not perfectly clean.
500 hours	12. Renew the fuel filter element.
1000 hours	13. Decarbonise if the engine shows loss of compression or blow-by past the piston, (do not disturb otherwise). 14. Adjust the valve clearances, with the engine cold. 15. Clean the cylinder and cylinder head fins under dusty conditions.
2000 hours	16. Decarbonise the engine.
5000 hours	17. Major engine overhaul if necessary.
12 months	18. Dismantle pump and examine for wear.

The general outline given above is based on Lister-Petter engines. Reference should be made to manufacturers manuals supplied with each pump for details and for other manufacturers. Comprehensive information concerning routine maintenance can be found either in the Operator's Handbook or Workshop Manual supplied with the pump sets.

Lubrication

The pumps are equipped with a mechanical seal which is lubricated by the liquid being pumped – always ensure body is full of liquid before starting. The bearings are sealed for life which is normally 25,000 hours and require no attention but should be replaced in case of noise or premature wear.

Routine maintenance schedule

CODE PR2-ALBS Light Weight Self-Priming Pump Powered by an Air Cooled Petrol Engine

Always disconnect battery cables and spark plug wire from spark plug before performing any maintenance operation requiring disassembly of the pump.

Daily	<ol style="list-style-type: none"> 1. With engine stopped, check level and condition of engine oil. 2. Remove chaff and debris from cylinder head fins and recoil starter finger guard. 3. Check fuel supply. 4. Check clack valve on pump inlet has free movement. 5. Drain water from pump, flush and fill with clean water. NB: If there is any chance of frost, water should be drained immediately after use. 6. Check and clean suction hose filter/foot valve if fitted.
50 hours	<ol style="list-style-type: none"> 7. Replace or clean sparking plug. 8. Clean air cleaner elements (2 No). 9. Check governor linkage, spring and controls, clean and lubricate as necessary. 10. Drain lubricating oil, refill with correct type and grade of oil. Check for leaks, tightening nuts and fittings as necessary.
125 hours	<ol style="list-style-type: none"> 11. Change air cleaner elements. 12. Carbon deposits should be removed from top of cylinder, cylinder head, top of piston and around valves.

General: The Kestrel engine driven pump is of glass reinforced polycarbonate (GRP) construction with a semi-open clog-resistant impeller and a Buna N (Nitrile rubber) mechanical seal with carbon/ceramic or carbon/carbide faces, designed for general purpose pumping and dewatering. It is compatible with most nonflammable liquids with temperatures of 4 – 49°C. and will handle solids in suspension up to 11mm.

Comprehensive information concerning Routine Maintenance can be found in the Operating Instructions and/or Owner's Manual supplied with each pumpset.

The routine servicing and maintenance periods given are based on average operating conditions. Under very dusty conditions air cleaners, lubricating oil and fuel filters will require more frequent attention. Decarbonising may be required more frequently when engines are running on light loads for long periods.

Safety precautions

- Ensure the engine is securely mounted.
- Ensure that there is an adequate supply of cooling and combustion air available to the engine.
- Never operate a diesel engine or standard electric motor powered unit in an explosive atmosphere, near combustible materials or where insufficient ventilation exists.
- Ensure the engine and surrounding area is kept clean.
- Ensure all safety guards are in position.
- Keep clear of all moving or hot parts and secure any items of loose clothing.
- Never allow any unprotected part of the body to come into contact with high-pressure fuel oil: for example when testing fuel injection equipment.
- Thoroughly clean any lubricating or fuel oil from the skin as soon as practicable after contact.
- Rectify all fuel and oil leaks as soon as practicable.
- Clean fuel and oil spillage as soon as they occur.
- Some of the materials used in the manufacture of filters and elements could give off toxic gases if they are burnt.
- The materials used in the manufacture and treatment of some filters may cause irritation or discomfort if they come into contact with the eyes or mouth.
- Used liquid filters and elements contain some of the filtered liquid and should be handled and disposed of with care.
- After handling new or used elements the users hands should be thoroughly washed, particularly before eating.
- Some engines may be fitted with seals of 'O' rings manufactured from VITON or a similar material. When exposed to abnormally high temperatures, in excess of 400°C (752°F), an extremely corrosive acid is produced which cannot be removed from the skin. If signs of decomposition are evident, or if in doubt, always wear disposable heavy-duty gloves.
- These pumps should only be used to pump clean or slightly polluted water and some mild chemicals between temperatures of 4°C and 80°C. Do not pump flammable liquids such as petroleum-based products.
- Observe all safety precautions for the handling of fuel and never refuel an engine whilst it is still running.
- The pump body must not be subjected to more than the rated internal pressure (14 bar for P4H, 10 bar for P4H, 5 bar for PR2). The pumps themselves cannot develop more pressure when operating at their normal speed maximum speed of 2,590 rpm (3,600 rpm for PR2), therefore:
 - Ensure that there is no high positive suction pressure (such as flooded situation) which would increase the total system pressure over the maximum limit
 - Do not exceed the maximum speed
 - Ensure that there are no quick-closing valves in the system which could generate hydraulic shock
 - Ensure that there are no sudden obstructions of the discharge line, such as a vehicle driving over the hose
- Do not run the pump dry and always ensure that the pump body is filled with water before starting up the pump.
- The lifting plates fitted to the engine are designed for lifting the engine and the fitted accessories. They must not be used to lift complete pump assemblies.

SECTION D - DETAILS OF KITS AND SUPPLIERS

Full list of kit contents

2" Atalanta Swallow 2100/Lister AC1 pumpset kit with hose

Oxfam code **P2-ALLI**

(approx gross weight 300 kg & volume 1.95 m³)

Item	Qty	Description
1.	1	Atalanta Swallow 2100, 2" single stage centrifugal self-priming pump. Lister-Petter AC1 single cylinder air-cooled diesel engine with crank handle start
2.	1 set	Connection accessories, comprising:
		Suction
	1	80mm Footvalve SOCLA 2543
	1	3" Hose clamp
	1	3" jubilee clip
	1	30M x 3" R/forced PVC Flexible Medium Duty hose
	1	3" BSP (F) MI Hose coupling with Hose clamp fitted to above
	1	3" (M) to 2" (F) BSP Reducer GS
	10	3" Hose coupling washers
		Discharge
	1	2" BSP (F) Gate Valve
	1	3" (M) to 2" (M) BSP Nipple GS
	1	3M x 3" Transparent PVC Medium Duty Hose (5 bar)
	2	3" BSP (F) Hose Couplings MI (fitted to both ends of above)
	2	3" Hose clamp (fitted to above)
	5	3" BSP Hex Nipple G.S
	1	2" (F) Swing Type Check Valve-brass
	3	3" BSP (F) 90 Degree Bend G.S
	2	3" BSP (F) Hose Coupling MI
	2	3" Hose clamp (fitted to above)
	10	3" Hose Coupling Washers
	3	10m Roll PTFE Tape (12mm wide)
3.	1 set	Mounting Bolts
	4	M10 x 100mm rag bolts washers and nuts
	4	3/8" x 3" coach screws and washers
4.	1 set	Pump spares for 1 year operation, comprising:
	1	Seal complete
	1	Inlet Gasket/clack valve
	2	Plug Washer
	1	Wear Plate
	2	Prime Plug
5.	2 set	Engine consumable spare sets each to cover approx 2,000 hours operation, comprising:
	1	Decarbonising Joint Set

	3	Fuel Filter Element
	8	Oil Filter Element
	4	Air Filter Element
	4	Joint washer
6.	1	Documentation (set)
	1	Lister Petter standard handbook and master parts list
	1	Atalanta operating instructions and parts list
	1	Oxfam Pump Pack Manual, (code PPM)
	1	Packing list and copy of Oxfam Users' Notes
7.	1	5 litre jerrycan with startup oil

Lister AC1 engine overhaul kit

Oxfam code **PE2-LI**

(approximate gross weight 8kg & volume 0.07m³)

Item	Qty	Description
1.	1	Gov. Shaft Bush
2.	1	Flanged Bush
3.	1	Small End Bush
4.	2	Nozzle
5.	2	Nozzle Seal Washer
6.	2	Valve Guide
7.	2	Valve
8.	2 Pr	Collets
9.	2	Valve Spring
10.	2	Relief Valve Assembly
11.	1	Main Bearing – F.W.E.
12.	1	Main Bearing – Gear End
13.	1	Camshaft Bush – Gear End
14.	1	Camshaft Bush – Inter
15.	1	Camshaft Bush - F.W.E
16.	1	Large End Bearing
17.	2	Con Rod Bolt
18.	2	Crank Thrust Washer
19.	1	Camshaft Thrust Washer
20.	1	Tabwasher – F/W Nut
21.	1	Tabwasher – F/W Nut
22.	1	Star Tolerance Ring
23.	2	Piston Ring Set – Std
24.	3	Decarbonising Joint Set
25.	3	Conversion Joint Set
26.	12	Fuel Filter Element
27.	12	Joint Washer
28.	12	Air Filter Element
29.	24	Lub Oil Filter Element
30.	1	Lister Petter AC1 Workshop Manual

2" Atalanta Swallow 2100 pump major repair kit

Oxfam code PS2-AI

(approx gross weight 4.4kg & volume 0.03m³)

Item	Qty	Description
1.	1	Seal complete
2.	1	Inlet gasket/clack valve
3.	2	Plug washer
4.	2	Prime plug
5.	1	Wear plate
6.	3	Shim
7.	1	Impeller

4" Atalanta Osprey 422 pumpset kit, Lister TS2 engine and hose

Oxfam code P4-ALLI

(approx gross weight 559kg & volume 2.57m³)

Item	Qty	Description
1	1	Atalanta Osprey 422 diesel pumpset, comprising: 4" x 4" centrifugal self priming pump 4" screwed BSP (M) suction and discharge connections. Lister Petter TS2 twin cylinder air cooled diesel engine with handle start.
2	1 set	Connection accessories
		Suction
	2	4" BSP (F) hose coupling
	1	4" (100mm) SOCLA footvalve, type 317
	2	4" bolted hose clips
	1	4" jubilee clip
	1	4" (F) x 3" (F) BSP reducing socket
	1	3" BSP (M) hex nipple
	1	4" BSP (M) hex nipple
	10	4" hose coupling washers
	1	10m 4" reinforced flexible medium duty suction hose
		Discharge
	1	3" BSP (F) brass gate valve, NP16
	1	3" swing check valve NP16
	1	4" (F) x 3" (F) BSP reducing socket
	4	12m rolls PTFE tape
	3	3" bolted hose clips
	5	3" BSP (M) hex nipple
	2	3" BSP (F) bend
	1	3" BSP (F) hose coupling
	10	3" hose coupling washers
	1	4m x 3" of 10 bar rated rubber reinforced hose, pre-fitted with 2 x 3" (F) BSP hose couplings
3.	1 set	Mounting bolts
	4	M10 x 100mm rag bolts, nuts and washers
	4	3/8" x 3" coach screw and washers

4.	1 set	Pump spares set for one year operation, comprising:
	1	Seal complete
	2	Inlet Gasket/Clack valve
	1	Outlet Gasket
	1	Body Gasket
	1	'O' Ring
	2	Plug
	2	Plug Washer
5.	2 sets	Engine consumable spare sets each to cover 2000 hours operation, comprising:
	1	Decarbonising Joint Set (Lister)
	4	Fuel Filter Element
	8	Lubricating Oil Filter
	1	Medium Duty Dry Type Air Cleaner
6.		Documentation
	1	Lister Petter standard handbook and master parts book
	1	Atalanta handbook operating instructions & parts book
	1	Oxfam Pumping Manual (code PPM)
	1	Packing list and copy of Oxfam Users Notes
7.	1	5 litre jerry can of start up oil

For 4" Atalanta Condor 1001-D275 Pump major repair kit see p 27

Lister TS2 engine overhaul kit with agglomerator (6000 hours operation)

Oxfam code PE4-L1

(approx gross weight 15kg & volume 0.05m³)

Item	Qty	Description
1.	1	T Series Workshop manual
2.	3	Decarbonising joint set
3.	12	Fuel filter element
4.	24	Lubricating oil filter
5.	3	Medium duty dry type air cleaner element
6.	4	Big end bearing
7.	8	Con rod bolt
8.	8	Con rod nut
9.	4	Piston ring set
10.	2	Inlet valve guide
11.	2	Exhaust valve guide
12.	2	Inlet valve
13.	2	Exhaust valve
14.	6	Fuel injector nozzle
15.	2	Sump joint

4" Atalanta Condor 1001 Pumpset Kit, Lister TS3 engine and hose.

Oxfam code P4H-PSLI

(approx gross weight 812kg & volume 3.49m³)

Item	Qty	Description																
1.	1	<p>'Atalanta' high head diesel pumpset, comprising:</p> <p>PUMP: 1 No (CONDOR 1001- D275) 4" x 3" centrifugal self priming pump in cast iron construction with mechanical seal. Bare shaft configuration with 4"screwed BSP (M) suction and 3" BSP (M) discharge connections.</p> <p>ENGINE: 1 No Lister-Petter TS3, 3 cylinder air cooled diesel engine with 12 volt electric start, emergency starting handle, charging alternator and battery pack, dry type air filter, 13.5 litre fuel tank, variable speed control, agglomerator, oil and fuel filters and exhaust silencer.</p> <p>Pump and engine are coupled together with a FENNER HRC110 flexible coupling and mounted on a fabricated steel skid type baseplate with suitable lifting holes, and drilled for 6 x M10 holding down bolts. 2 No 50mm diameter holes to be drilled opposite each other, through each side of the base frame, approximately one third of the way along the frame under the engine, to provide additional lifting points. Complete with discharge hardware support bracket supplied loose.</p>																
2.	1 set	<p>Connection accessories, comprising:</p> <p>SUCTION</p> <table border="1"> <thead> <tr> <th>Qty</th> <th>Description</th> </tr> </thead> <tbody> <tr> <td>2</td> <td>3" BSP hexagon nipple, GS</td> </tr> <tr> <td>1</td> <td>4" BSP (F) hose coupling (malleable iron)</td> </tr> <tr> <td>2</td> <td>4" bolted hose clamp</td> </tr> <tr> <td>1</td> <td>4" jubilee clip</td> </tr> <tr> <td>1</td> <td>4" (F) x 3" (F) BSP reducing socket, GS</td> </tr> <tr> <td>10</td> <td>4" hose coupling washers</td> </tr> <tr> <td>1</td> <td>10m x 4" reinforced PVC flexible medium duty low toxic suction hose, pre-fitted with hose coupling and 4" (100mm) SOCLA foot valve, type 317 cat no 2546.</td> </tr> </tbody> </table> <p>(Extra fittings provided in case water is being pumped directly from an Oxfam tank, so foot valve would not be used in this case)</p>	Qty	Description	2	3" BSP hexagon nipple, GS	1	4" BSP (F) hose coupling (malleable iron)	2	4" bolted hose clamp	1	4" jubilee clip	1	4" (F) x 3" (F) BSP reducing socket, GS	10	4" hose coupling washers	1	10m x 4" reinforced PVC flexible medium duty low toxic suction hose, pre-fitted with hose coupling and 4" (100mm) SOCLA foot valve, type 317 cat no 2546.
Qty	Description																	
2	3" BSP hexagon nipple, GS																	
1	4" BSP (F) hose coupling (malleable iron)																	
2	4" bolted hose clamp																	
1	4" jubilee clip																	
1	4" (F) x 3" (F) BSP reducing socket, GS																	
10	4" hose coupling washers																	
1	10m x 4" reinforced PVC flexible medium duty low toxic suction hose, pre-fitted with hose coupling and 4" (100mm) SOCLA foot valve, type 317 cat no 2546.																	

		<p>DISCHARGE</p> <table border="1"> <thead> <tr> <th>Qty</th> <th>Description</th> </tr> </thead> <tbody> <tr> <td>1</td> <td>3" BSP(F) brass swing check valve</td> </tr> <tr> <td>2</td> <td>3" BSP (F) brass gate valve, (with cast iron handle)</td> </tr> <tr> <td>4</td> <td>12m rolls PTFE tape (12mm wide)</td> </tr> <tr> <td>3</td> <td>3" bolted hose clamps (86 x 91mm)</td> </tr> <tr> <td>5</td> <td>3" BSP hexagon nipple, GS</td> </tr> <tr> <td>2</td> <td>3" BSP (F) bend, GS</td> </tr> <tr> <td>2</td> <td>3" BSP (F) hose couplings, malleable iron</td> </tr> <tr> <td>1</td> <td>3" BSP (M) hose coupling, malleable iron</td> </tr> <tr> <td>10</td> <td>3" hose coupling washers</td> </tr> <tr> <td>1</td> <td>4m length of 3" Ø 10 bar rated rubber, reinforced hose, suitable for potable water, pre-fitted with 2 x 3" (F) BSP hose couplings and clamps</td> </tr> <tr> <td>1</td> <td>3" BSP (F) equal tee, GS</td> </tr> </tbody> </table> <p>Qty Description</p> <table border="1"> <tbody> <tr> <td>6</td> <td>M10 x 100mm rag bolts, washers and nuts</td> </tr> <tr> <td>6</td> <td>3/8" x 3" coach screws and washers</td> </tr> </tbody> </table> <p>Qty Part Number Description</p> <table border="1"> <tbody> <tr> <td>1</td> <td>35-3-124</td> <td>Seal complete</td> </tr> <tr> <td>1</td> <td>35-3-107</td> <td>Body gasket</td> </tr> </tbody> </table> <p>5. 2 sets ENGINE CONSUMABLE SPARE SETS EACH TO COVER 2,000 HOURS OPERATION, EACH SET COMPRISING:</p> <table border="1"> <thead> <tr> <th>Qty</th> <th>Part Number</th> <th>Description</th> </tr> </thead> <tbody> <tr> <td>1</td> <td>657-29521</td> <td>Decarb joint set</td> </tr> <tr> <td>4</td> <td>751-18100</td> <td>Fuel filter element</td> </tr> <tr> <td>8</td> <td>201-55370</td> <td>Lubricating oil filter</td> </tr> <tr> <td>4</td> <td>366-07188</td> <td>Medium duty type air cleaner element</td> </tr> </tbody> </table> <p>Qty Description</p> <table border="1"> <tbody> <tr> <td>1</td> <td>Engine Service Manual and illustrated parts list</td> </tr> <tr> <td>1</td> <td>Pump Operator's Manual/Parts List</td> </tr> <tr> <td>1</td> <td>Oxfam Pumping Pack Manual (Oxfam Code PPM)</td> </tr> <tr> <td>1</td> <td>Packing List including Oxfam's User's Notes</td> </tr> <tr> <td></td> <td>Each to be placed in individual grip-seal bags</td> </tr> </tbody> </table> <p>7. 1 5 litre jerry can of start up oil</p>	Qty	Description	1	3" BSP(F) brass swing check valve	2	3" BSP (F) brass gate valve, (with cast iron handle)	4	12m rolls PTFE tape (12mm wide)	3	3" bolted hose clamps (86 x 91mm)	5	3" BSP hexagon nipple, GS	2	3" BSP (F) bend, GS	2	3" BSP (F) hose couplings, malleable iron	1	3" BSP (M) hose coupling, malleable iron	10	3" hose coupling washers	1	4m length of 3" Ø 10 bar rated rubber, reinforced hose, suitable for potable water, pre-fitted with 2 x 3" (F) BSP hose couplings and clamps	1	3" BSP (F) equal tee, GS	6	M10 x 100mm rag bolts, washers and nuts	6	3/8" x 3" coach screws and washers	1	35-3-124	Seal complete	1	35-3-107	Body gasket	Qty	Part Number	Description	1	657-29521	Decarb joint set	4	751-18100	Fuel filter element	8	201-55370	Lubricating oil filter	4	366-07188	Medium duty type air cleaner element	1	Engine Service Manual and illustrated parts list	1	Pump Operator's Manual/Parts List	1	Oxfam Pumping Pack Manual (Oxfam Code PPM)	1	Packing List including Oxfam's User's Notes		Each to be placed in individual grip-seal bags
Qty	Description																																																												
1	3" BSP(F) brass swing check valve																																																												
2	3" BSP (F) brass gate valve, (with cast iron handle)																																																												
4	12m rolls PTFE tape (12mm wide)																																																												
3	3" bolted hose clamps (86 x 91mm)																																																												
5	3" BSP hexagon nipple, GS																																																												
2	3" BSP (F) bend, GS																																																												
2	3" BSP (F) hose couplings, malleable iron																																																												
1	3" BSP (M) hose coupling, malleable iron																																																												
10	3" hose coupling washers																																																												
1	4m length of 3" Ø 10 bar rated rubber, reinforced hose, suitable for potable water, pre-fitted with 2 x 3" (F) BSP hose couplings and clamps																																																												
1	3" BSP (F) equal tee, GS																																																												
6	M10 x 100mm rag bolts, washers and nuts																																																												
6	3/8" x 3" coach screws and washers																																																												
1	35-3-124	Seal complete																																																											
1	35-3-107	Body gasket																																																											
Qty	Part Number	Description																																																											
1	657-29521	Decarb joint set																																																											
4	751-18100	Fuel filter element																																																											
8	201-55370	Lubricating oil filter																																																											
4	366-07188	Medium duty type air cleaner element																																																											
1	Engine Service Manual and illustrated parts list																																																												
1	Pump Operator's Manual/Parts List																																																												
1	Oxfam Pumping Pack Manual (Oxfam Code PPM)																																																												
1	Packing List including Oxfam's User's Notes																																																												
	Each to be placed in individual grip-seal bags																																																												

Lister TS3 Engine overhaul kit with agglomerator (6000 Hours operation)

Oxfam code PE4H-LI

(approx gross weight 18kg & volume 0.05m³)

Item	Qty	Part no.	Description
1	1	027-08221	T series workshop manual
2	6	657-29521	Decarbonising joint set
3	24	351-29760	Fuel Filter element
4	48	201-55370	Lubricating oil filter
5	12	366-07188	Medium duty dry type, air cleaner element
6	6	570-31370	Big end bearing
7	12	201-80300	Con rod bolt
8	12	270-00778	Con rod nut
9	6	570-12910	Piston ring set
10	3	201-30181	Inlet valve guide
11	3	201-30171	Exhaust valve guide
12	3	201-30040	Inlet valve
13	3	201-30051	Exhaust valve
14	9	201-81395	Fuel injector nozzle
15	2	202-3054	Sump joint

4" Atalanta Condor 1001-D275 Pump major repair kit

Oxfam code PS4H-PS

(approx gross weight 3kg & volume 0.03m³)

Item	Qty	Part no.	Description
1	1	35-3-124	Seal complete
2	2	35-3-107	Body Gasket
3	1	35-3-117	Impeller CI Ø275
4	2	35-3-181	Impeller locking nut
5	1	35-3-182	Spring lock
6	1	35-3-183	Locking nut joint
7	1	35-3-160	Sunk key (10 x 8 x 56)
8	1	35-3-121	Ball bearing (6308 - 2RS1)
9	1	35-3-122	Ball bearing (6307 - 2RS1)
10	1	35-3-108	Non return valve

2" Pumpsets Kestrel 101/Briggs and Stratton, petrol, lightweight pumpset kit.

Oxfam code PR2-ALBS

(approximate gross weight 52kg & volume 0.24m³)

Item	Qty	Description
1.	1	KESTREL 101 - 2" Self-priming pump of thermoplastic construction fitted with long life carbide/carbon mechanical seal and BSP male steel outlet and inlet sockets, flanged coupled to a Briggs & Stratton 085432 4 HP "Vanguard" OHV petrol engine, complete with low oil protection, mounted inside a tubular steel roll over frame with anti-vibration mounts.
2.	1	6M length of 50mm lightweight vinyl suction hose
3.	1	15M length of 50mm layflat delivery hose
4.	1	2" BSP female high impact polypropylene hose coupling with a 90 degrees bend
5.	1	2" BSP female high impact polypropylene hose coupling, straight
6.	1	50mm push-on thermoplastic filter/footvalve
7.	3	2" hose clips
8.	1	Briggs and Stratton Operations Manual
9.	1	Tool kit comprising: spark plug spanner, screwdriver and oil drain plug spanner
10.	5	0.6 litre containers of start-up engine oil (each container allowing 1 complete refill)
10.	1	Empty 5 litre plastic petrol can
11.	1 set	<i>Spares for 500 hours operation, comprising:</i> 1 spark plug, 1 air filter element, 1 air filter cartridge, 1 right angle female coupling, 1 straight female coupling, 2 x 2" BSPT/NPT barrel nipples, 3 x 2" hose clips.
12.	1 set	Oxfam Instruction Manual for Water Pumping equipment (Oxfam Code PPM)

4" Atalanta Osprey 422/452 Pump major repair kit

Oxfam code PS4-AL/1

(approx gross weight 5kg & volume 0.02m³)

Item	Qty	Description
1.	1	Seal complete
2.	1	Inlet gasket/Clack valve
3.	1	Outlet gasket
4.	1	Body gasket
5.	1	Plug
6.	1	Plug washer
7.	1	Impeller
8.	1	'O' ring
9.	3	Shim
10.	1	Impeller Washer
11.	1	Impeller Bolt

Pump Oil Kit

Oxfam code PO

(approximate gross weight 66Kg & volume 0.20m³)

Item	Qty	Description
1.	2	SAE 15W/40 Lubricating oil in 25 litre drum
2.	1	Funnel and strainer
3.	1	20 Litre steel jerry can with lockable top and 2 spare washers

Pump Fittings Kit for pumps in parallel and bypass for pumping into distribution

Oxfam code PF

(approximate gross weight 12kg & volume 0.01m³)

Item	Qty	Description
1.	1	3" Ø BSP (M) hose coupling
2.	1	3" bolted hose clip
3.	2	3" Ø BSP (F) tee
4.	2	3" (M) x 1" (F) hex reducing bush
5.	1	1" Ø BSP (F) brass ball valve
6.	1	1" Ø BSP (M) hex nipple
7.	2	1" Ø BSP (M) x 32mm Ø PVC compression coupling
8.	4	12m rolls PTFE tape

Re-ordering

If it is necessary to re-order individual items, please describe as specified in the above list and quote name and code of the kit in which the item occurs and specify part no. and engine number for engine parts.

List of suppliers used by Oxfam (based in the United Kingdom)

The "Oxfam" pump kits, codes PR2, P2, P4H, P4, PS2, PE2, PS4H, PE4H, PS4, PE4, are supplied by:

PumpSets Ltd, PO Box 1615, Andover,
Hampshire, SP10 5NP
Tel: 01264 333737; Fax: 01264 333108

The pump fitting kit, codes PF, is supplied by;

Evenproducts Ltd, Oxtalls Farm, Evesham,
Worcestershire, WR11 4TS
Tel: 01386 41212; Fax: 01386 765404

The oil kit kit, codes PO, and tool kits are supplied by;

Kennedy International Ltd, PO Box 14, Wigston
Works, Victoria Street, Wigston, Leicester
LE8 1AJ
Tel: 01533 881616; Fax: 01533 81239