

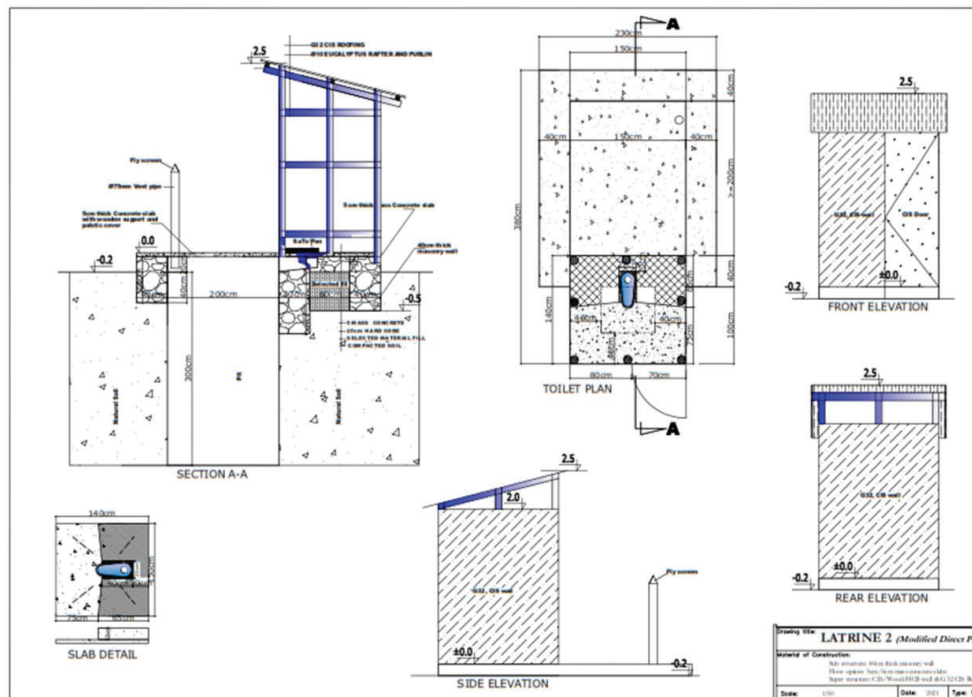

Manufacturing Sanitation Product and Latrine Construction

Short Term Training

Based on May 2023, Curriculum Version I



Module Title: Read and Interpret Working Drawing and Specifications

Module code: EIS SCW1 M02 0523

Nominal duration: 8 Hours

TABLE OF CONTENTS

Acknowledgment	ii
Introduction to the Module	1
Unit One:	2
1.1. Introduction to free hand sketching.....	3
1.2. Orthographic view /2D.....	3
1.3. Isometric perspective/3D.....	4
Unit Two: Architectural symbols and abbreviations	8
2.1. Drawing Symbols and Abbreviations.....	9
2.2. Sanitary Symbols.....	11
2.3. Electrical Symbols.....	12
Unit Three: Types of working drawings and their purposes	14
3.1. Architectural Drawing.....	15
3.2. Structural Drawing.....	19
3.3. Sanitary Drawing.....	23
3.4. Electrical Drawing.....	24
3.5. Detail drawing.....	25
Reference	29
Participants of This Module (Training Material) Preparation	30

ACKNOWLEDGMENT

The Ministry of Labor and skill would like to extend its gratitude to MoH, One WASH national Program, USAID, PSI, Regional Labor, and skill/training Bureaus, TVT College Deans, Instructors, and industry experts for their financial and technical support of Manufacturing Sanitation Product and Latrine Construction training module. Finally, MOLS extends its gratitude to the following instructors and experts who contributed to the development of curriculum.

Mulualem Misganaw, Senior Expert /TVT Sector, MOLS

Mesfin Habtemariam (MA), Engineering Technical Manager, PSI/TWASH

Bacha Kitesa (MPh, MA), WASH Capacity Development Manager, PSI/TWASH

Fisum G/Egizebiher (MPh), WASH Business Development Manager, PSI/TWASH

Dagim Demirew (MPh), Associate Director, WASH Business development, PSI/TWASH

Ziyad Ahmed (MPh), Senior Expert, MOH

Wondayehu Wube (MPh), Senior Expert, MOH

Andualem Ababayhu (MSC), Instructor, Debark PTC

Mesfin Wondimu (BSc), Instructor, Aleta Wondo PTC

Girema Moges (BSc), Instructor, Wolayita PTC

Dagim Fekadu (MSc), Instructor, Ambo PTC

Solomon Tadese (BSc), Instructor, GWPTC

Esmael Mohammed (BSc), Instructor, Kombolcha PTC

Desalegn Alemu (Bsc), Instructor, Woliso PTC

Tesfaye Assegidew (MSc), Instructor, Butajira PTC

INTRODUCTION TO THE MODULE

In construction work, reading and interpreting plans is essential for doing any structural work to put on the ground as per the drawing, and calculating quantities for estimation in a construction project helps to know the quantity of work, estimate the quantity of material required, determine the cost of the work, estimate the expected project completion time, and know the required manpower for the given project.

This module is designed to meet the industry requirement under the Manufacturing sanitation products and latrine construction for short-term training, particularly for the unit of competency **Read and Interpret Working Drawings and Specifications**, which covers the knowledge and skills required to read and interpret plans and specifications relevant to construction operations. It includes the identification of types of plans and drawings and their functions, the recognition of commonly used symbols and abbreviations, the identification of key features and specifications on a site plan, and the recognition of document status and amendment detail.

This module covers the following units:

- Introduction to free hand sketching and views
- Architectural symbols and abbreviations.
- Types of Working drawings and their purposes.

Learning Objective of the Module

- Introduce free hand sketching and views.
- Identify Architectural symbols and abbreviations.
- Identify types of drawings and their purposes

Module Instruction

For effective use of this module, trainees are expected to follow the following module instruction:

1. Read the information written in each unit.
2. Accomplish the Self-checks at the end of each unit.
3. Perform Operation Sheets at the end of units.
4. Do the "LAP test" given at the end of each unit and
5. Read the identified reference book for Examples and exercise.

Unit One: Introduction to free hand sketching and views

This unit is developed to provide trainees the necessary information regarding the following content coverage and topics:

- 1.1. Introduction to Free Hand sketching
- 1.2. Orthographic view /2D
- 1.3. Isometric perspective/3D

This unit will also assist trainees to attain the learning outcomes stated below. Specifically, upon completion of this learning guide, trainees will be able to:

- Introducing to Free Hand sketching
- Understand Orthographic view /2D
- Understand Isometric perspective/3D

1.1. Introduction to free hand sketching

Freehand sketch: often used in the field to convey or clarify minor points of information between engineers and site workers. Site workers also need to know how to draw freehand sketches, as they may need to bring information back to update system drawings with changes that were made in the field.

A drawing is a graphic representation of a real thing. To draw something as a figure by means of lines expressing the same ideas on the paper is called drawing.

The purpose of drawing is to define and specify the shape and size of a particular object by means of lines; other information about the object that cannot be expressed by lines is given side by side on the drawing in the simplest and shortest way possible. There are two basic types of drawings: Artistic and Technical drawings.

Artistic Drawings

Artistic drawings range in scope from the simplest line drawing to the most famous paintings. Regardless of their complexity, artistic drawings are used to express the feelings, beliefs, philosophies, and ideas of the artist.

Technical Drawings

The technical drawing, on the other hand, is not subtle or abstract. It does not require an understanding of its creator, only an understanding of technical drawings.

A technical drawing is a means of clearly and concisely communicating all of the information necessary to transform an idea or a concept into reality. Therefore, a technical drawing often contains more than just a graphic representation of its subject. It also contains dimensions, notes, and specifications.

1.2. Orthographic view /2D

Orthographic view is a technique that is used to create multi view drawings. i.e two-dimensional drawings used to represent or describe a three-dimensional object. More than one view is needed to represent the object. That is Multi view drawing.

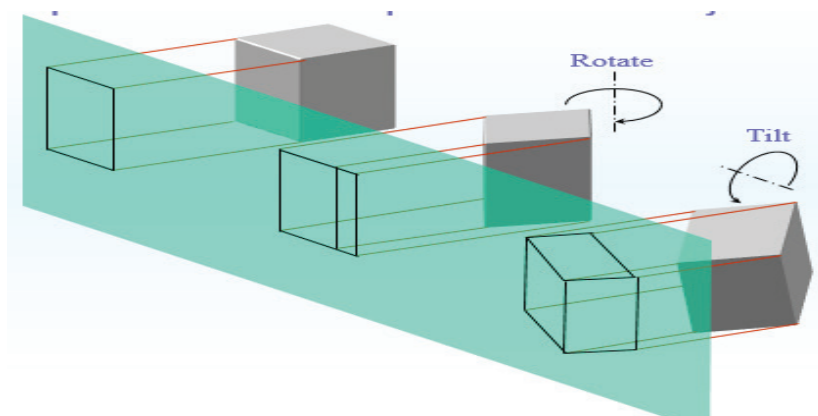

Fig.1. 1 Orthographic view

A multiview drawing is one that shows two or more two-dimensional views of a three-dimensional object. **Multiview drawings** provide the shape description of an object. When combined with dimensions, multiview drawings serve as the main form of communication between designers and manufacturers.

Multi view Projections: Project an object from six principal directions (front, back, top, bottom, right, left)

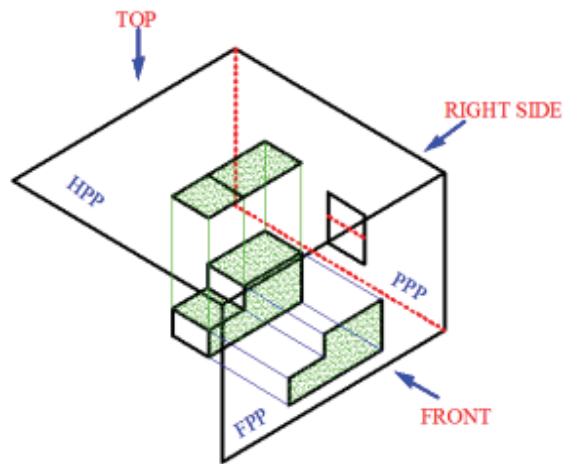

fig1. 2 Multi view Projections

1.3. Isometric perspective/3D

Isometric projection is a method for visually representing three-dimensional objects in two dimensions in technical and engineering drawings. It is an axonometric projection in which the three coordinate axes appear equally foreshortened and the angle between any two of them is 120 degrees.

Isometric drawing, also called isometric projection, method of graphic representation of three-dimensional objects, used by engineers, technical illustrators, and, occasionally, architects.

The technique is intended to combine the illusion of depth, as in a perspective rendering, with the undistorted presentation of the object's principal dimensions—that is, those parallel to a chosen set of three mutually perpendicular coordinate axes.

The isometric is one class of orthographic projections. In making an orthographic projection, any point in the object is mapped onto the drawing by dropping a perpendicular from that point to the plane of the drawing.

An isometric projection results if the plane is oriented so that it makes equal angles (hence “isometric,” or “equal measure”) with the three principal planes of the object.

Isometric projection

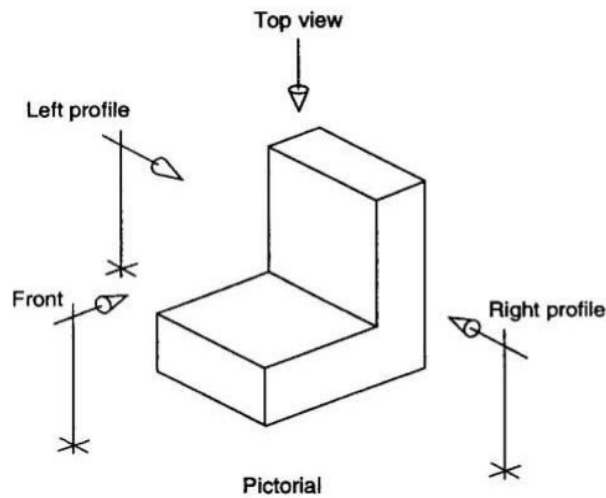
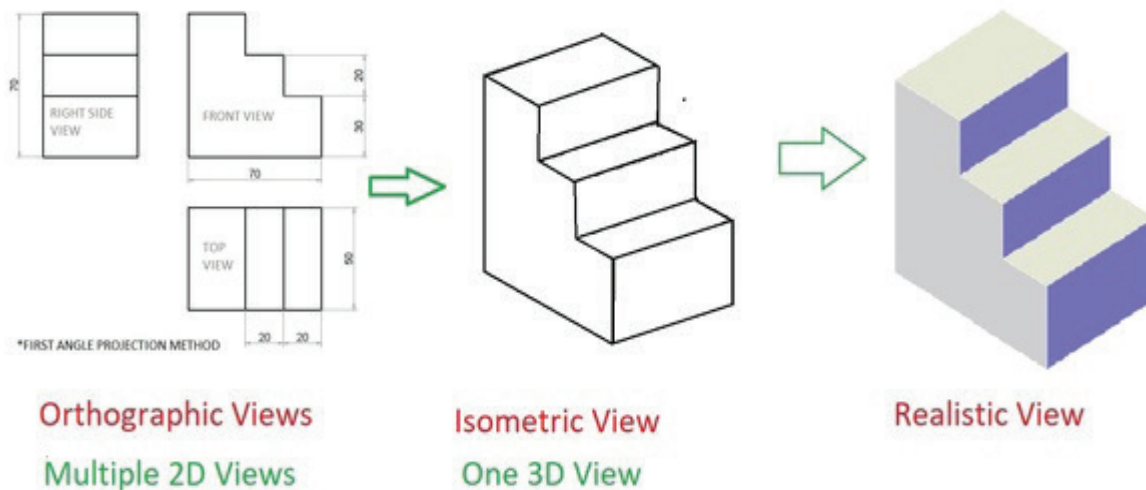

fig1. 3 Isometric Projections

The main difference between Orthographic projection and Isometric Projections: -

The main difference between the two types of projection is the way in which they are used to create an object's shape. Orthographic projection creates an object by utilizing multiple, parallel projected views, while isometric projection creates an object by utilizing three-dimensional space and angles.



Self-check--1

Test-I: Choose the best answer. Each itmes have 2 points

- Which is not a type of drawing?
 - Artistic drawing
 - Orthographic drawing
 - Technical drawing
 - None
- are drawings that attempt to replicate what the human eye actually sees when it views an object?
 - Parallel projection
 - Perspective projection
 - Orthographic drawing
 - ALL
- One of the following is not correct about an aspect of building drawing?
 - Parallel projection
 - Orthographic drawing
 - Perspective projection
 - None

Test-II: write short answer.

- Write the diference between artistic and technical drawing?
- Write the diference between Ortographic and parallal projection?

Note: Satisfactory rating – above 75% Unsatisfactory - below 75%

You can ask your trainers for the copy of the correct answers.

Operation sheet 1.1: To draw Multi view drawing to a free hand sketching.

Purpose: To draw 2D drawing from a 3D drawing, do a freehand sketch of the given 3D drawing below.

Equipment Tools and Materials:

- Paper
- Pencil
- Eraser
- Drawing board or table

Steps in doing the task.

1. Set up the drawing paper on top of the drawing board.
2. Check to see that the paper edges are parallel to the left and bottom edges of the board respectively.
3. Properly secure the paper on top of the table by using masking tape or tacks or the likes.
4. Be sure to check the sharpness of your pencil lead. Use standard sharpening for good aesthetic result of your work.
5. Apply the knowledge on line quality in your work.
6. Accuracy and aesthetics always go hand in hand with drafting, so do your work with quality.
7. You may submit your finish work once you are true but should be within the time specified for submission.

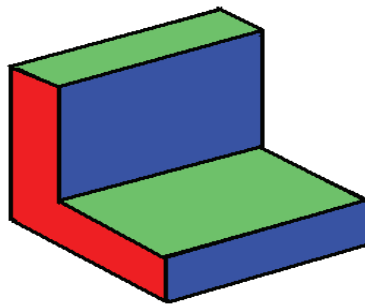

Quality Criteria: Assured performing of all the activities according to the procedures.

Lap Tests

Name: _____ Date: _____

Time started: _____ Time finished: _____

Instructions: Given necessary templates, tools, and materials you are required to perform the given tasks accordingly.

Task 1: Perform the 2D view of the object

Unit Two: Architectural symbols and abbreviations

This unit to provide trainees the necessary information regarding the following content coverage and topics:

- 2.1. Drawing Symbols and Abbreviations
- 2.2. Sanitary Symbols
- 2.3. Electrical Symbols

This guide will also assist trainees to attain the learning outcomes stated below. Specifically, upon completion of this learning guide, trainees will be able to:

- Identify drawing symbols and abbreviations.
- Identify sanitary symbols.
- Identify electrical symbols.

2.1. Drawing Symbols and Abbreviations

Introduction

Some drawings need to convey a lot of information. To avoid confusion and save space, abbreviations and symbols are used. These are standardized, and you'll find that you soon become used to interpreting what they mean. In this section, you'll be introduced to some of the more common abbreviations and symbols.

Abbreviations & Symbols

Drawing abbreviations and symbols are used to communicate and detail the characteristics of an engineering drawing. This list includes abbreviations common to the vocabulary of people who work with engineering drawings in the manufacture and inspection of parts and assemblies.

Abbreviations can be created in different ways. In some cases, the word is shortened. A list of common abbreviations found on drawings or in general use in structural engineering, architecture, and construction.

Technical standards exist to provide glossaries of abbreviations, acronyms, and symbols that may be found on engineering drawings. Many corporations have such standards, which define some terms and symbols specific to them.

a. Architectural Abbreviation

HCB-Hollow concert block	CB-Concert Block	S - Single shutter
AR- architectural	CIS-Corrugated iron sheet	D - Door
W-Window	GIS-Galvanized iron sheet	FF- Floor Finishing

b. Structural abbreviation

F- Footing	C- Column	GB- Grade Beam
L- Lintel	J- Joists	RCC- Reinforcement Concert
S- Slab	UB- Upper Tie Beam	C/C- Center to Center
IB- Intermediate Beam	FC- Footing Column	CIS-Corrugated iron sheet

C. Sanitary abbreviation

WC-Water Close	UR - Urinal	SH- Shower
BT - Bath Tub	ST - Septic Tank	D- Roof Drain
AV- Air Vent	MH- Manhole	HWB- Hand Wash Basin
SOV- Shut off Valve.	V- Vent	VS- Vent Stack

Symbols: the representation of an actual object by some notation that conveys the necessary information. Symbols are used instead of words on drawings to save space. There are a lot of them, but they're standardized (drawn the same way) to avoid confusion. Some of them look a lot like what they represent.











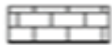





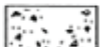



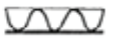
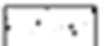

 Brick	 BRICKWORK	 EARTH
 Ceramic tile	 CEMENT RENDER	 EARTH FILL
 Glass	 CONCRETE	 ROCK
 Wood	 CUT STONE MASONRY	 HARDCORE
 Brick	 PARTITION BLOCK	 INSULATION
 Concrete	 CONCRETE BLOCK	 GLASS
 Earth	 STRUCTURAL STEEL	 TIMBER
 Concrete block	 SANITARY FITTINGS	 SAWN TIMBER
	 ROOF TILES	 DRESSED TIMBER

Fig-2. 1 Materials Symbols



DOORS 	WINDOWS 	FURNITURE 	STAIRS 
	SANITARY 		Elevator 
			Chimney 

Fig – 2.2: Common symbols of Door, windows and other materials

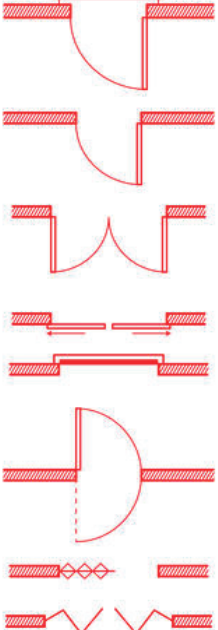
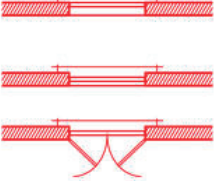
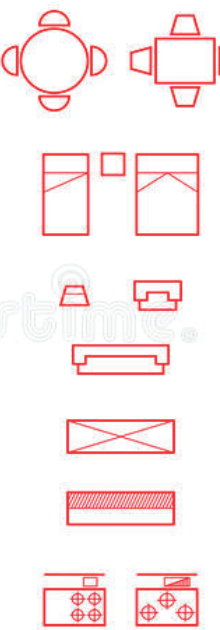
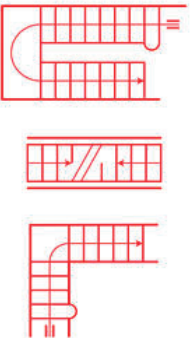
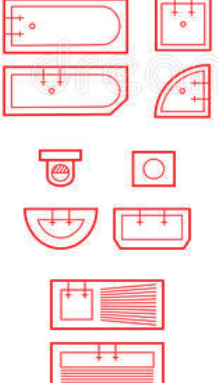
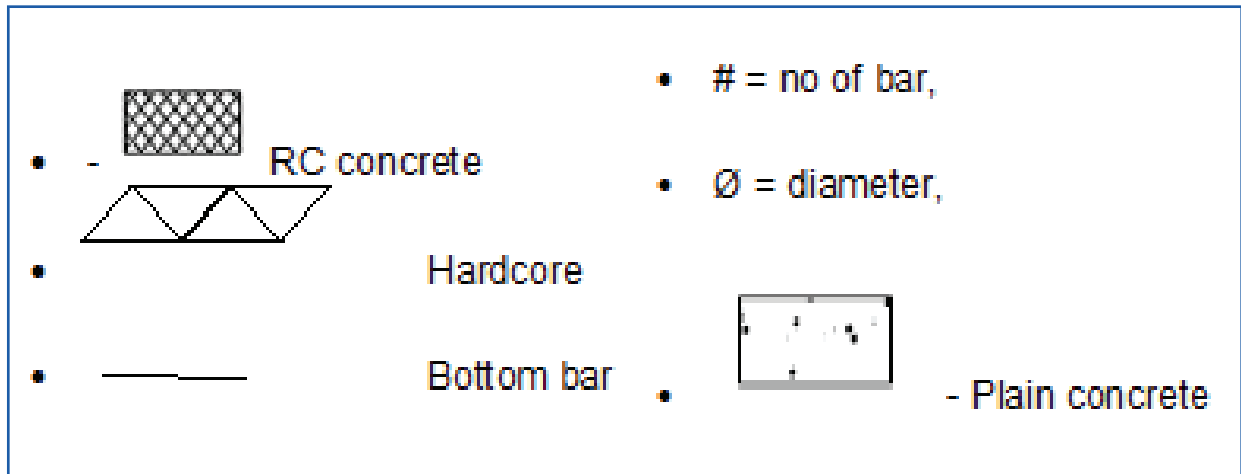

Fig - 2.3. Structural symbols

2.2. Sanitary Symbols

Shown below on the table are some symbols currently found on plumbing installation plan.















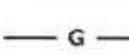



	Water Meter		Cold Water
	Hot Water		Vent Line
	Sanitary Waste		Gas Pipe
	Gate Valve		Water Heater Shut Off
	Water Closet		Lavatory
	Water Heater		Dishwasher
	Clothes Washer		Floor Drain
	Clean Out		Vent Thru Roof
	90 degree Elbow		Pipe Turns Up
	Pipe turns Down		Tee
	Union		Cap

Fig-2. 4 Plumbing symbols

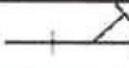
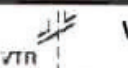
2.3. Electrical Symbols

Shown below are some symbols currently found on wiring diagram or electrical plan.

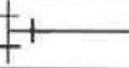
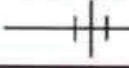
Circuit Symbols

Complete the table with either the symbol or the name of the symbol.

Name	Symbol
Ammeter An ammeter is connected in series.	
Voltmeter A voltmeter is connected in parallel.	
Cell	
Bulb	
Resistor	
Variable Resistor	
Switch (open & closed)	
Motor	
Buzzer	

SYMBOL	DESCRIPTION
Supply Lines (cont'd)	
	Junction of conductors for surface installations
	Earthing
	Surface mounted (central) main distribution board
	Flush mounted (central) main distribution board
	Surface mounted sub-distribution board
	Flush mounted sub-distribution board
Switchgear	
	Fuse, general
	Three-pole fuse, general
	Low voltage-HRC fuse
	Fuse disconnect
	Switch
	Automatic breaker for line protection

Fig-2.5 Electrical symbols

Common Blueprint Symbol

Architectural	Electrical	Plumbing
Sliding Door	Switched Outlet	Bath Tub
Bifold Door	TV Outlet	Shower
Pocket Door	220v. Outlet	Toilet
Door	Switch (single)	Dishwasher
Double Door	Phone Jack	Hot Water Heater
Window	Door Bell	Sink
Opening	Thermostat	Double Sink
Poured Cement	Brass Floor Receptacle	Floor Drain
Brick	Wall Light/Sconce	Water Meter
Framing Lumber	Ceiling Light	Gas Pipe
Concrete Block	Ceiling Fan	Hot Water
Stairs	Range	Cold Water
Fireplace	Dryer	Sanitary Waste

Self check - 2

Test-I. Write True or False

Instruction: Write True or False for the given questions. You have given 1 Minute for each question. Each question carries 2 Point.

1. Abbreviations are a quick method of writing on a plan without taking up too much space?
2. In construction # this symbol is represent the dimeter of bar?
3. The abrivations of C/C in construction implice center of the circle?
4. Symbols are the representation of actual object by some notation which conveys the necessary information?

Test II: short Answer writing

Instruction: write short answer for the given question. You are provided 3 minutes for each question and each point has 5 Points.

1. Write the purpose of Construction abbreviations?
2. Write the purpose of Construction symbols?

Note: Satisfactory rating – above 75% Unsatisfactory - below 75%

You can ask your trainers for the copy of the correct answers.

Unit Three: Types of working drawings and their purposes

This unit to provide Trainees the necessary information regarding the following content coverage and topics:

- 3.1. Architectural drawing
- 3.2. Structural drawing
- 3.3. Sanitary drawing
- 3.4. Electrical drawing
- 3.5. Detail drawing

This guide will also assist Trainees to attain the learning outcomes stated below. Specifically, upon completion of this learning guide, terainees will be able to:

- Explain Architectural drawing.
- Explain Structural drawing.
- Explain Sanitary drawing.
- Explain Electrical drawing.
- Explain Detail drawing

3.1. Architectural Drawing

Architectural drawings can be termed the mother drawing for all the other drawings used for construction. It contains all the details of the project, such as the location site plan, setting out plan, elevations, sections, and other details.

Various types of Architectural Drawings commonly used are:

Floor plans: A floor plan is the most fundamental architectural diagram; a view from above shows the arrangement of spaces in a building in the same way as a map but shows the arrangement at a particular level of a building.

Floor plan specifies describe:

- Dimensions of overall block work and room sizes to rough stud frames.
- Trim openings of all windows and doors.
- Space allowance for refrigerator and white goods.
- Location and spacing of all columns and verandah posts.
- Roof and eave lines as dashed lines
- Doors and windows to describing the details of each.
- Internal dimensions to establish positions of internal walls or fittings.
- Thickness of walls
- Door swings and windows
- Location of fittings and fixtures
- Names on all rooms
- Floor finishes
- Position of stairs and number of stair treads

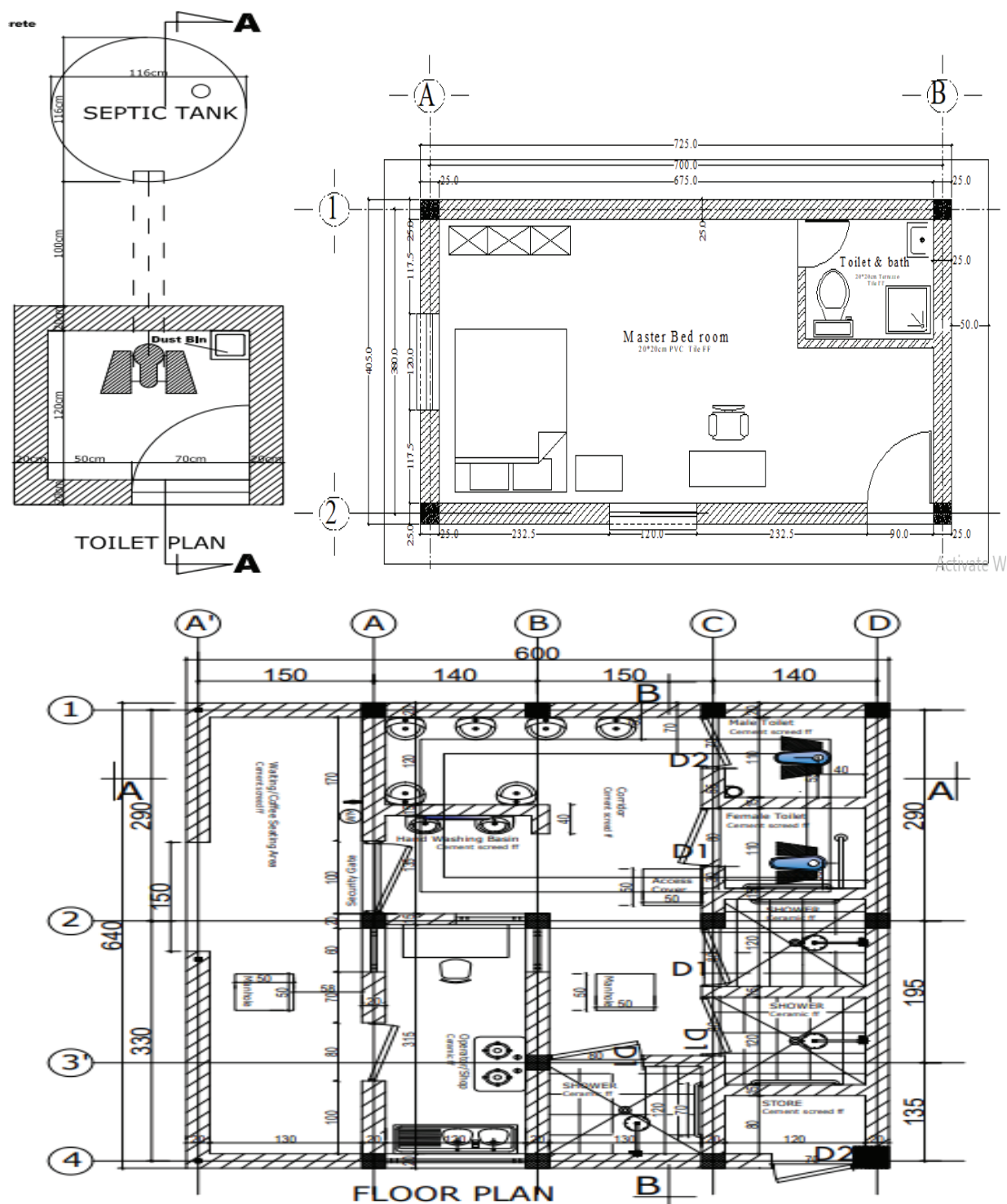

Fig-3.1: Typical samples of Floor plans

Sectional Drawings: Section drawings represent the material of construction to be used, heights and measurement of the different components of buildings, type of structural components such as type of slab, etc. It is representing the drawing when the building is cut through a vertical plane.

Sectional drawing can be describe.

- The relationship between different levels of a building.
- Depict a part or whole of the framework in sliced form.
- It helps understand the measurements of various building components with each other.
- The materials used in the construction of those components, the height, depth, and hollowness, etc.

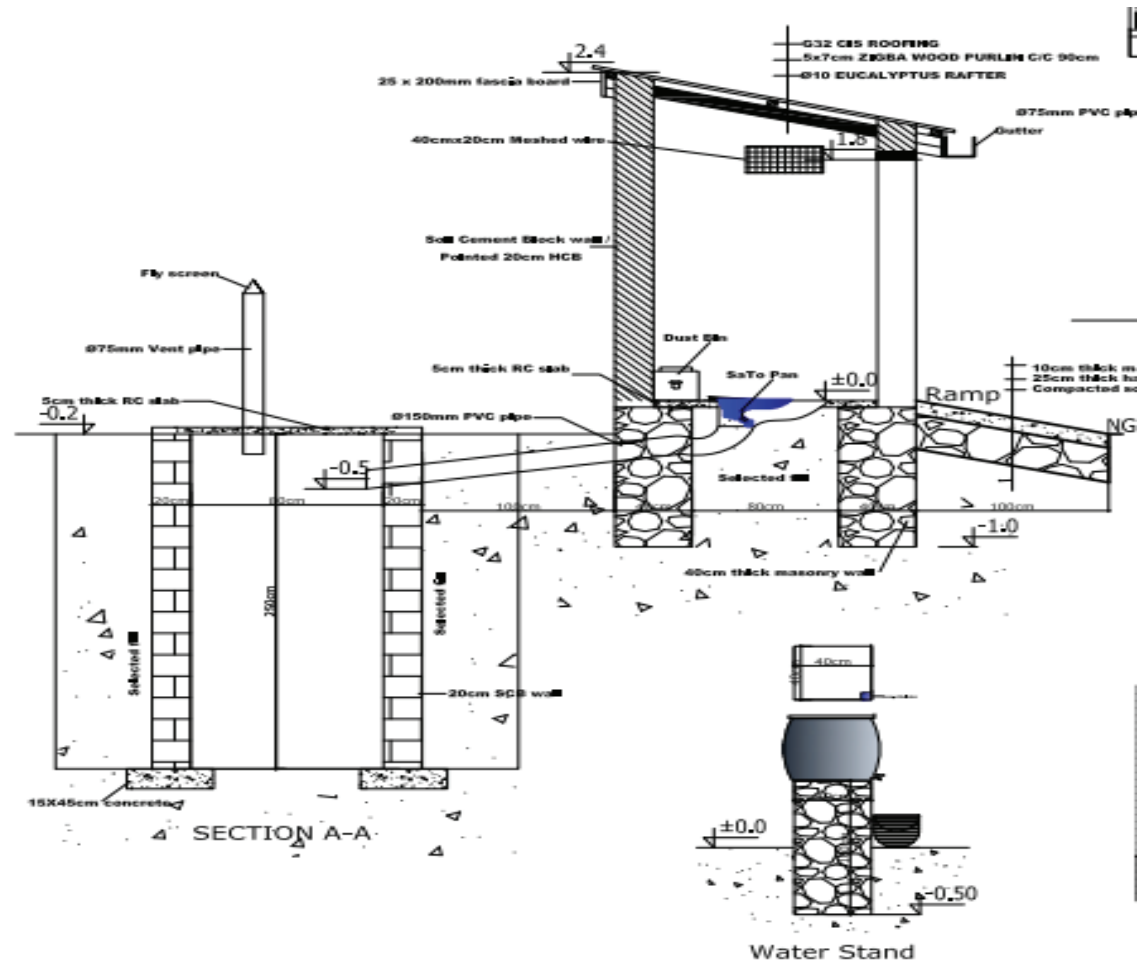

Fig-3.2: Sectional Drawing

Elevation Drawings

An elevation is a view of a building seen from one side, a flat representation of one façade. This is the most common view used to describe the external appearance of a building. Each elevation is labeled in relation to the compass direction it faces, e.g., the north elevation of a building is the side that most closely faces north. These architectural drawings offer an aesthetic overview of the various components of the building, such as columns, windows, and doorframes.

Elevation drawing commonly shows: -

- The relative surface, internal markings, and relative height of these different components to each other.
- Things that can't be shown in plain view; for example, the height of the windows and how far the sills are from the floor. This would be difficult to show clearly on the floor plan.

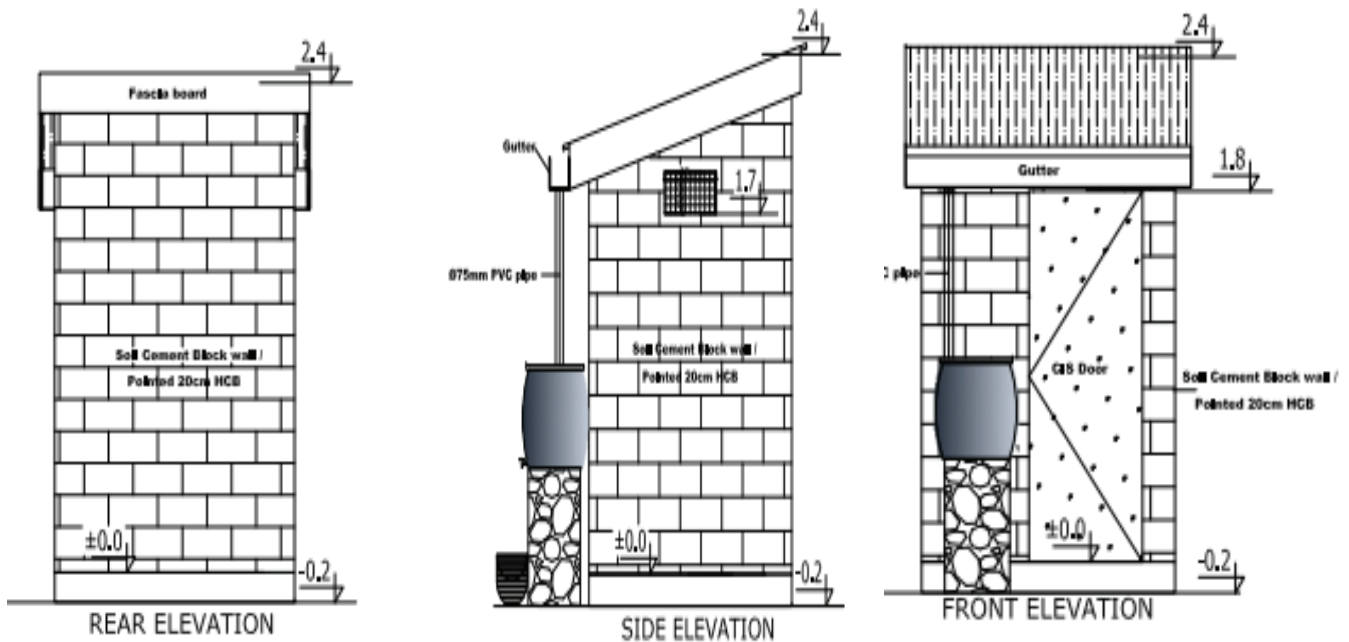

Fig- 3.3: Part of an elevation.

Site plans - A site plan is a specific type of plan, showing the whole context of a building or group of buildings.

A site plan shows:

- Property boundaries and means of access to the site and nearby structures if they are relevant to the design.
- The position and use of any other buildings within the property boundary
- The position and width of any adjacent streets
- The entire block of land, or at least the part of the block where the building will be.
- Most importantly, they show where the building is to be located on the block.
- Show things like driveways, fences, clothes lines, paths and retaining walls. These things are called 'ancillary' works (that is, additional to the main building works and usually of a relatively minor nature).

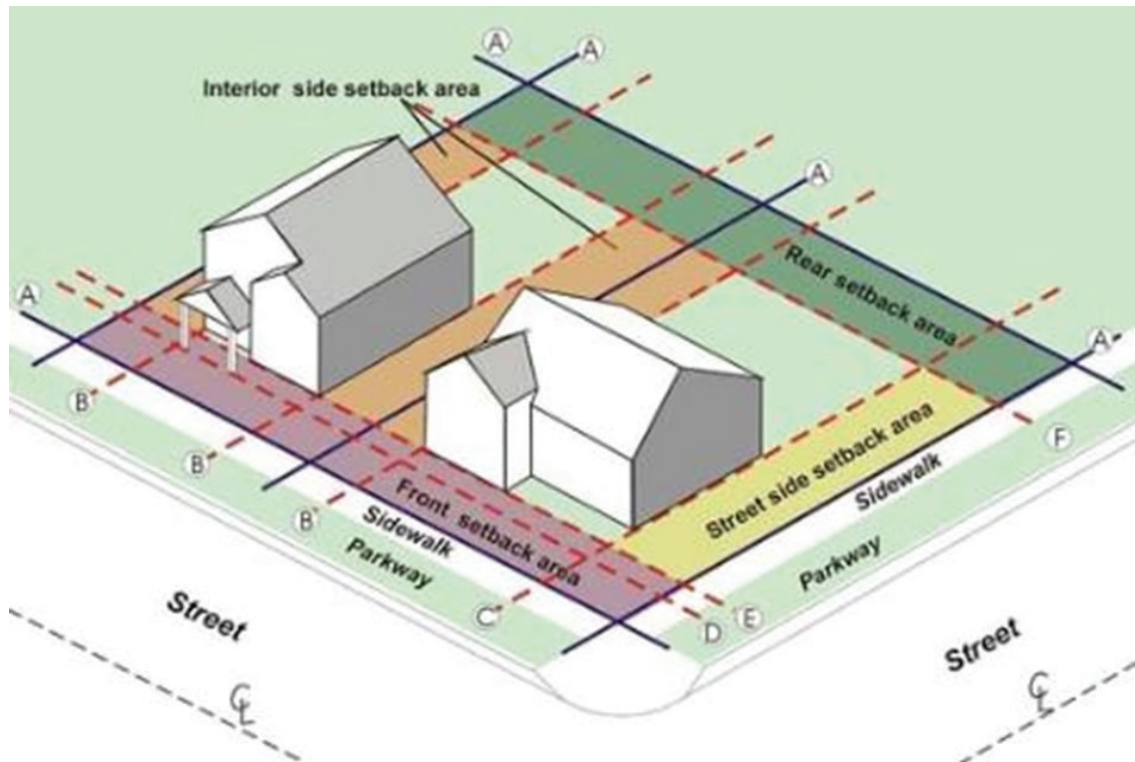

fig3. 4 site plan

3.2. Structural Drawing

Structural drawings also serve as civil engineering drawings. They are useful in understanding the physical nitty-gritty of a building framework. They act as a structural design guide for the workers and on-site engineers.

Common types of structural drawings are:

Foundation plan: It is a drawing showing the site and configuration of the floor plan. It is a drawing that shows the location of foundation wall concrete footings and other structures that must be supported by foundation walls and concrete footings.

Foundation plan is mostly shows:

- All components such as the foundation wall footings, grade beams & any sub structure elements.
- Wall thickness and Grid lines
- Position at which detailed of foundation taken.
- Level for excavation
- Position of wall relative to foundation.
- Dimension
- Position of services to be installed below ground level footing and grade beam
- It draws the same scale to the floor plan.

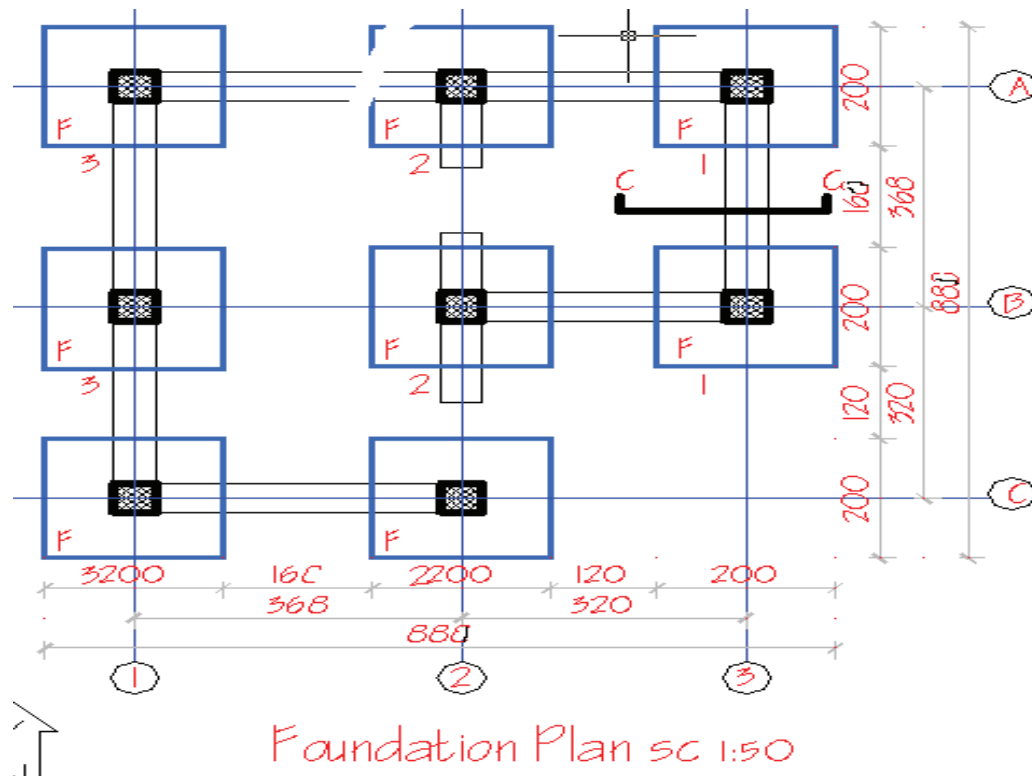

Fig-3.5 Foundation plan

General Note: An overview of all the codes, procedures, abbreviations, etc. required to give a comprehensive guide to getting to work on the construction site. This includes concrete mix, details for other structural drawings, lengths and construction types of each component, etc.

Excavation Drawing: This civil engineering drawing describes the dimensions and positions for the excavation process prior to the actual building work. It covers details like tunneling, shafts, removal of soil, grid plans, etc. required to start the groundwork.

Column Layouts: These structural drawings include the layouts of the way columns will be laid out. It makes it easier for contractors to plan the layout of the building and start the process by identifying the position and distance between columns across the floor.

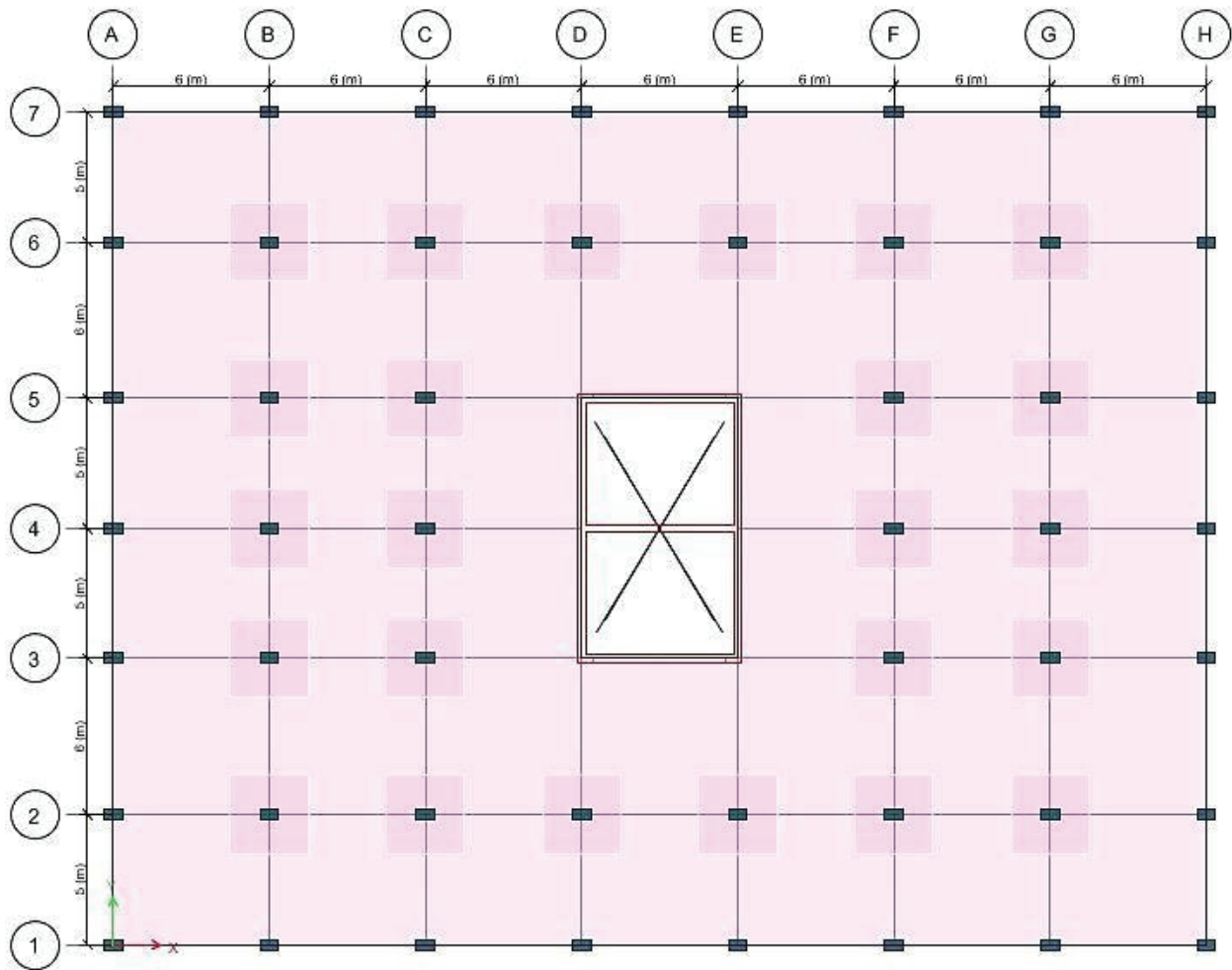

Fig-3.6 Columun layout

Beam Layouts: It includes all the beam-like structures, such as the ones supporting the roof and the windows, or the beams used for strengthening purposes. They are designed for each floor and cover the length, height, material, etc.

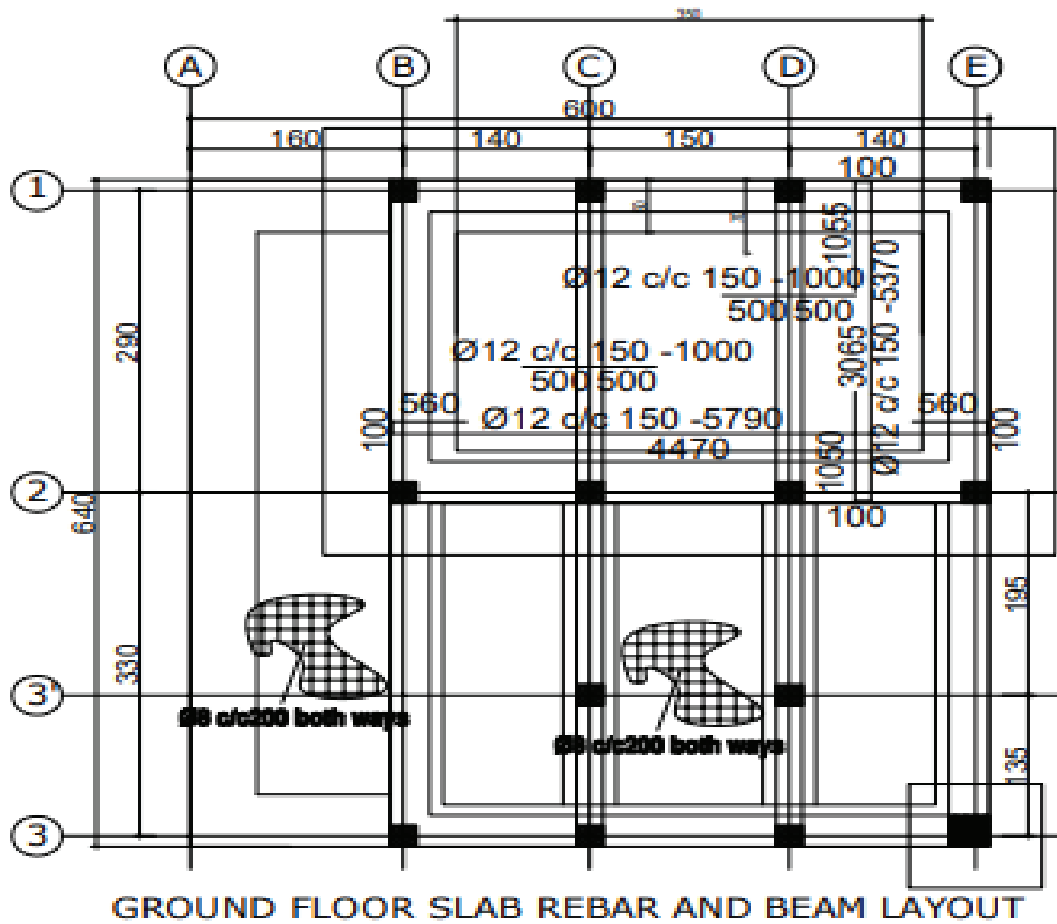

Fig-3. 7 Ground floor slab rebare, beam and columun layout

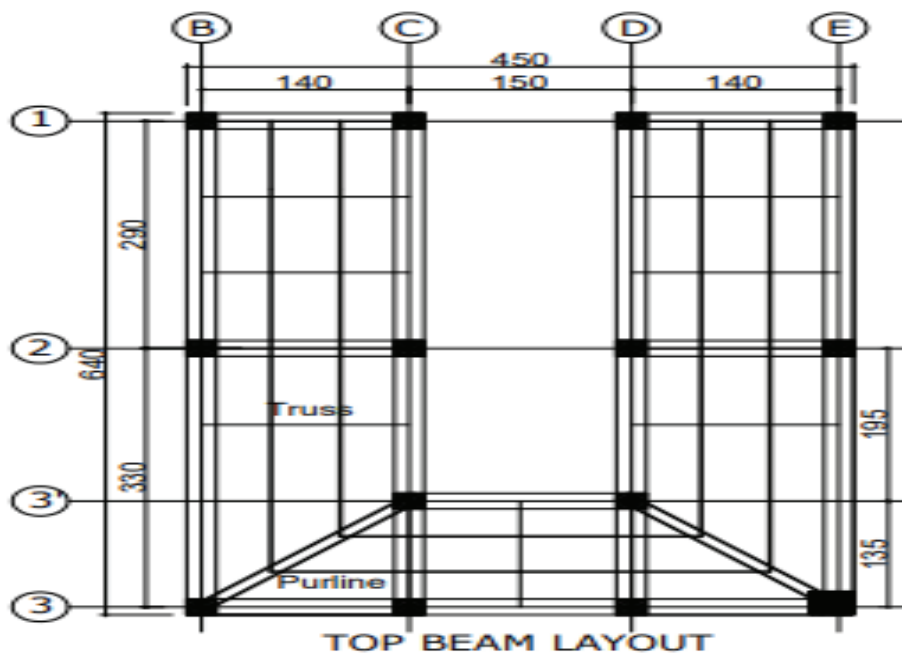

Fig-3. 8 Top beam and columun layout

Roof slab layouts: this civil engineering drawing describes the exact dimensions of the entire slab required for roofs or slants. It can be designed using AutoCAD software, as it requires precision and data.

3.3. Sanitary Drawing

Plumbing is another part of any residential or commercial construction drawing that marks the points where plumbing components need to be set up. Space is left here accordingly for further pipe and sanitary ware fixtures to be added once the structural component is finished. Plumbing drawings commonly include:

- Pipes –water pipes, drainage pipes, internal pipes
- Material of pipes
- Outlet points – taps, sinks, tanks etc
- Position and location of pipes and outlets
- Plumbing drawings give the location of sanitary, piping for water supply system, fixture, and the process to connect every fixture.

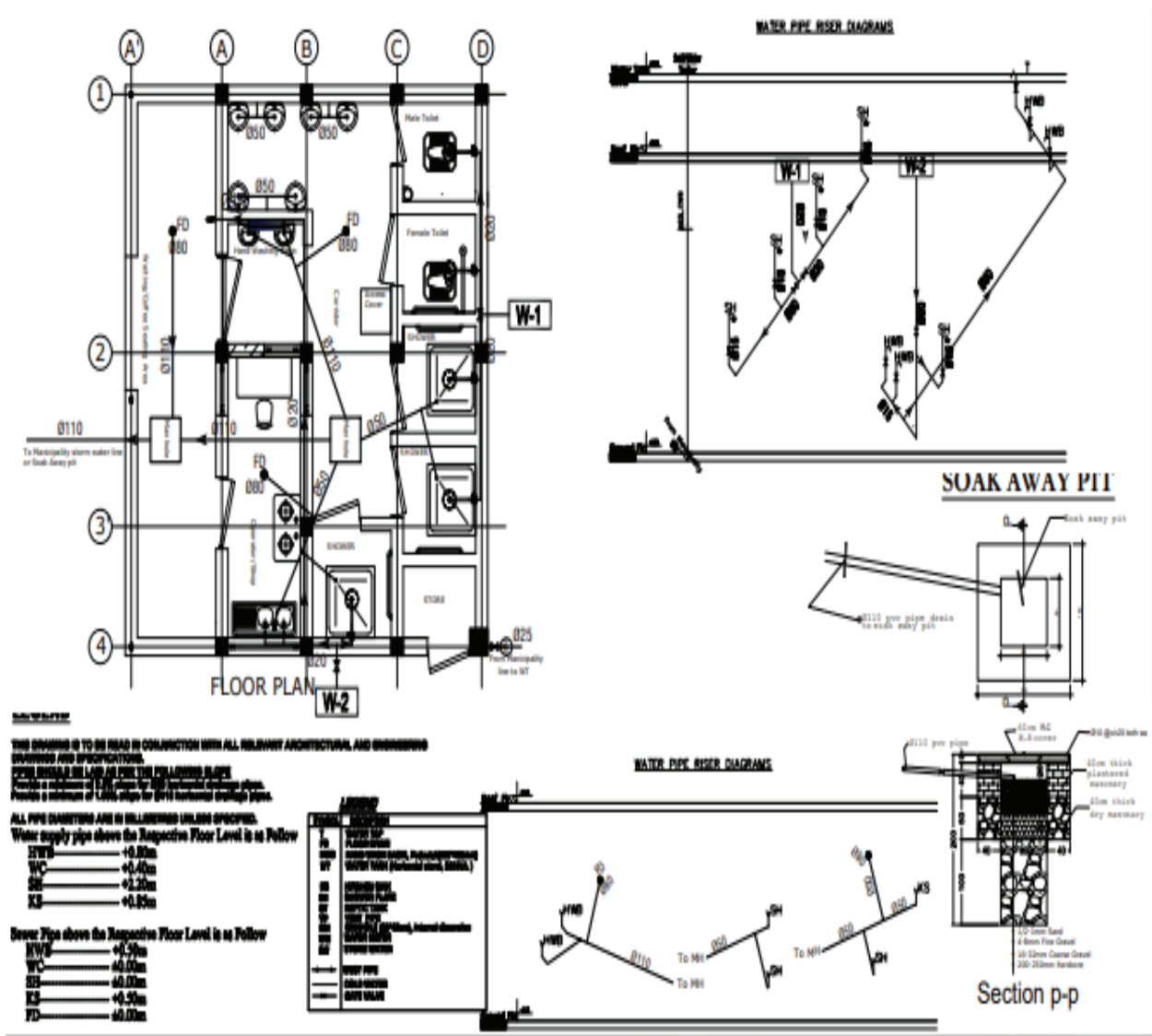

Fig-3.9: Plumbing Drawing

3.4. Electrical Drawing

The electrical plan is sometimes called an electrical drawing or wiring diagram. It is a type of technical drawing that delivers a visual representation and describes circuits and electrical systems. It consists of electrical symbols and lines that showcase the engineer's electrical design to its clients.

Electrical Drawings shows:

- Light and socket fixture layout
- Location of distribution board
- Tv and telephone outlet
- Earthing layout
- Generator and other equipment
- Cable tray layout
- Lighting protection system etc.

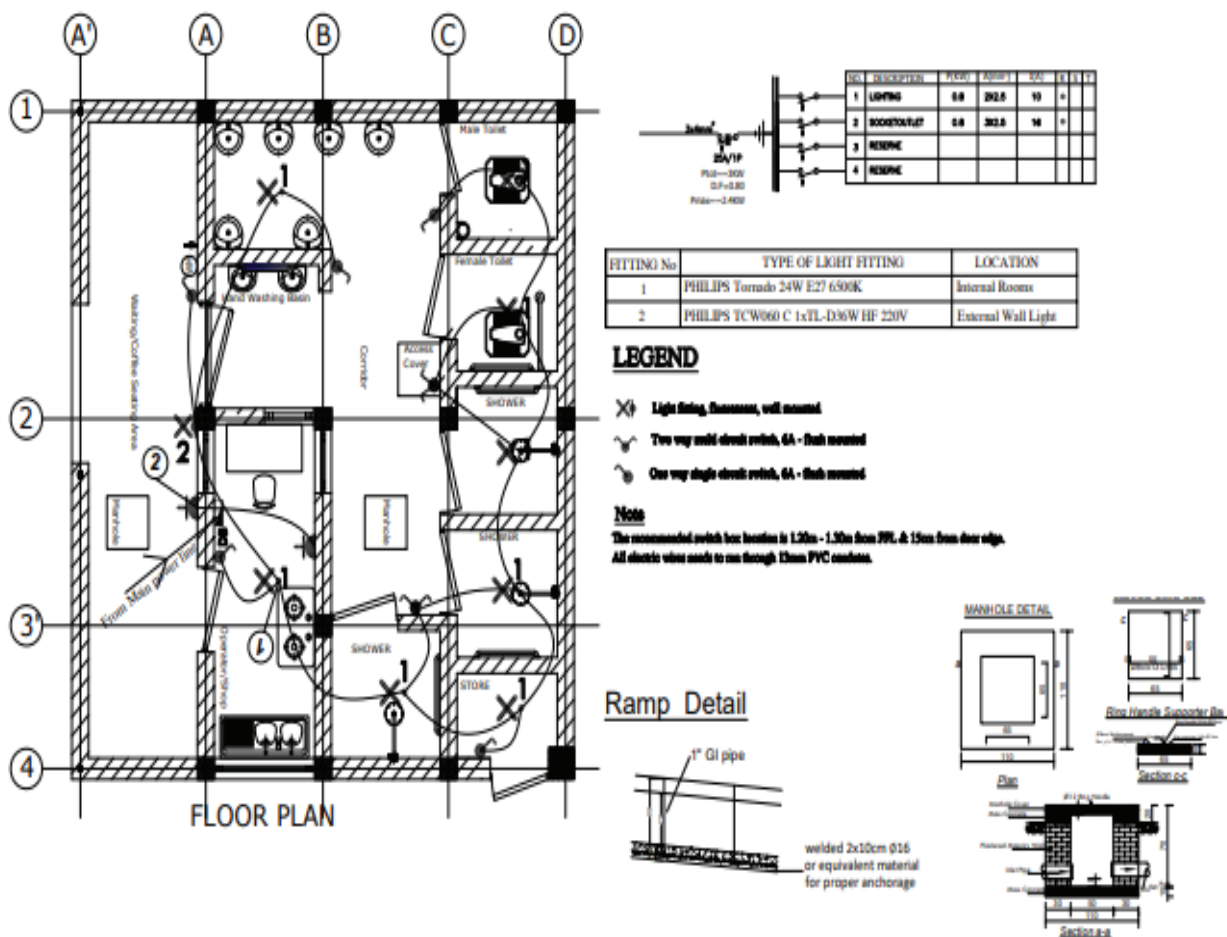
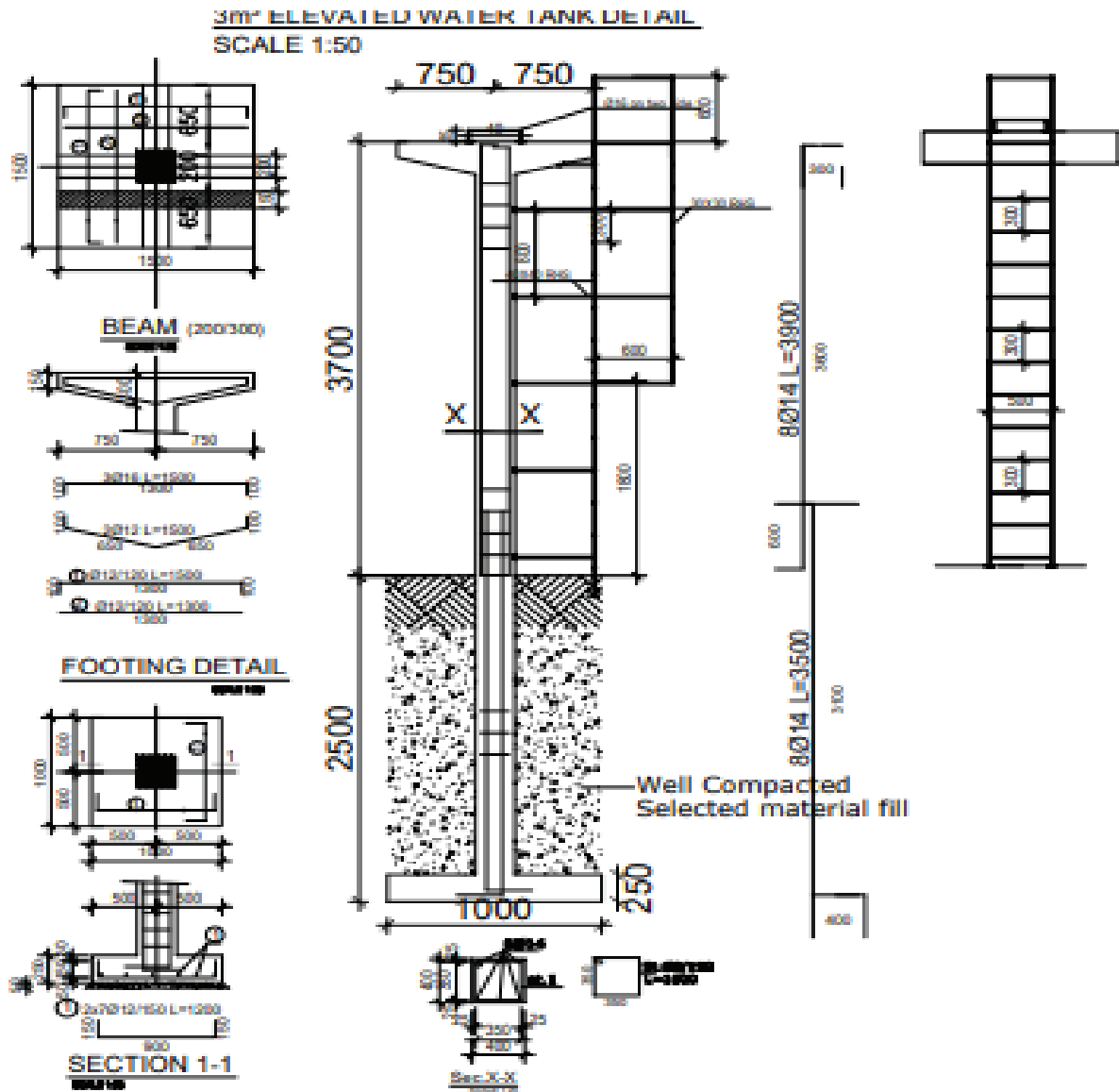

Fig-3.10: Electrical drawing

3.5. Detail drawing

A detail is a view that shows important details of certain parts of the building, hence its name. Details are drawn at a large scale so that the builder can see exactly how that part of the job is to be done.



a) Footing and footing column detail drawing

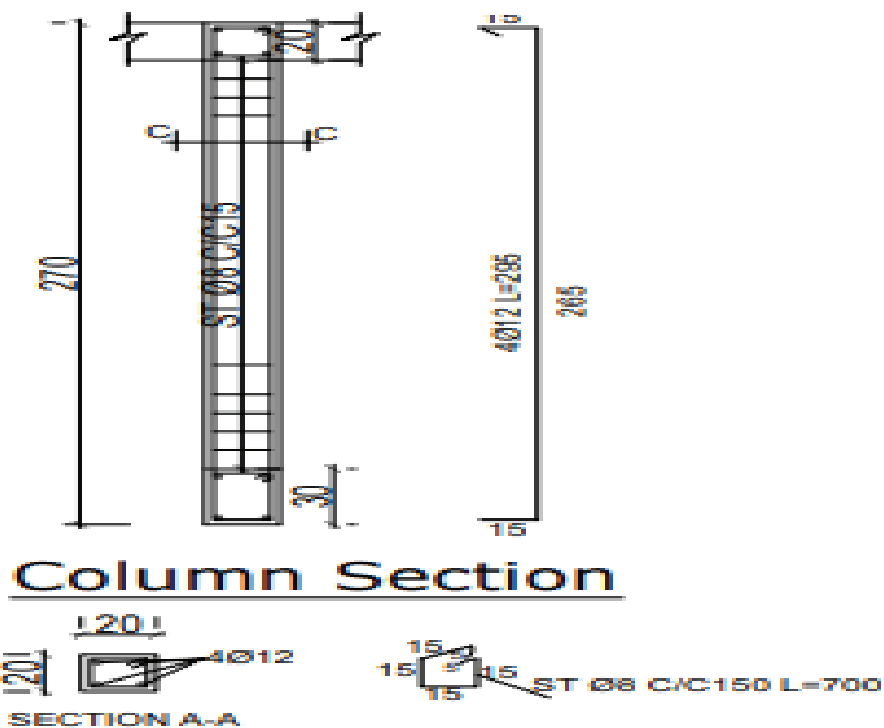

b) Elevation column detail drawing

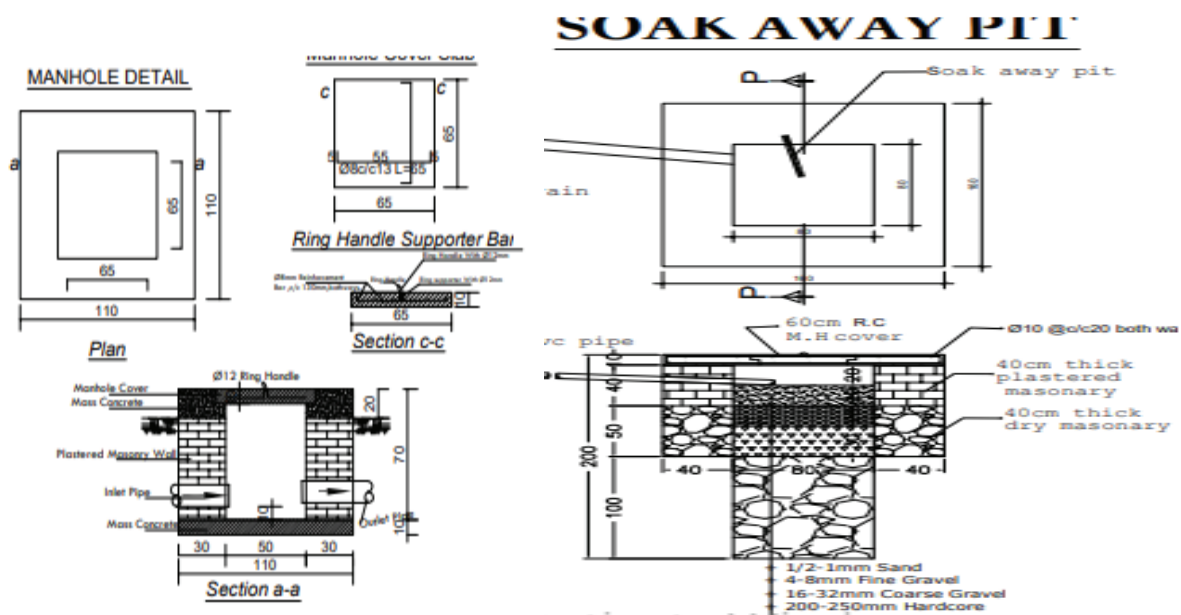

c) Manhole and soak away pit detail.

Fig-3.11: a,b,c detail Drawings

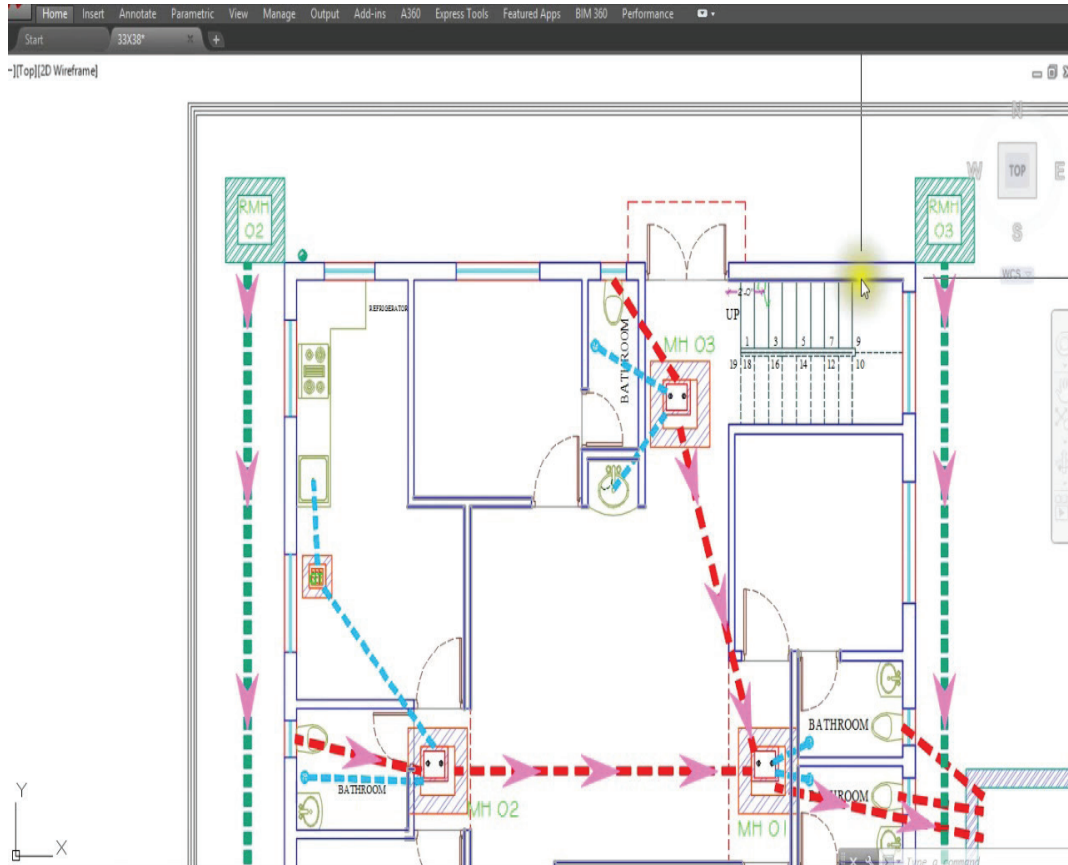

Fig-3.12: Plumbing digital Drawing.

Self check - 3

Test-I. Write True or False

Instruction: Write True or False for the given questions. You have given 1 Minute for each question. Each question carries 2 Point.

1. Plans and drawings are not essential for plumbing experts to install plumbing fixtures.
2. The function of floor plan drawing is to locate and show the types and uses of plumbing fittings.
3. As a requirement to construct buildings, only accurate plans are drawn to describe a particular object or building.
4. Thickness of foundation walls, external and internal, shown on the floor plan.
5. A cross-section drawing shows the entire building's construction and also shows the interior spaces in elevation taking on the long axis of the building.

Test-II. Choose

Instruction: select the correct answer for the give choice. You have given 1 Minute for each question. Each question carries 2 Point.

1. It is a view of a building containing a height dimension to show the height of the building, window, and door.
A. Elevation B. Detail C. Floor plan D. Foundation plan
2. Types of construction plans that show the location of the house on the site together with information on terraces, walks, driveways, contours, elevation, and utilities.
A. Floor plan B. Foundation plan C. Site plan D. None
3. Drawings provide dimensioned, graphical information that can be used by a contractor to construct the works or by suppliers to fabricate components of the works or to assemble or install components.
A. Construction working drawing B. Technical drawing C. Design drawing.
4. Which one does not define a good, detailed drawing?
A. Easy to supervise.
B. Reduced participation of the designer in the construction phase.
C. Simplify information.
D. Designer participation is necessitated in each construction phase.
E. None
5. ----- is a type of plan that is to show and locate the position and arrangements of pipelines and fixtures for sanitation.
A. Floor plan C. plumbing plan
B. Electrical plan D. isometric plan

Test III: short Answer writing

Instruction: write short answer for the given question. You are provided 3 minutes for each question and each point has 5Points.

1. Write the purpose of plans and Drawings?
2. Write down at least three functions of floor plan?
3. What is the difference between floor plan and plumbing plan?

Note: *Satisfactory rating – above 75%* *Unsatisfactory - below 75%*

You can ask your teraines for the copy of the correct answers.

REFERENCE

- Seeley IH. (1998). Building Quantities Explained 5th Revised edition, Macmillan ISBN 978-0-333-71972-5
- Read and interpret plans and specification Structural construction works Level-I Based on March 2022, Curriculum Version 1 MoLS module

PARTICIPANTS OF THIS MODULE (TRAINING MATERIAL) PREPARATION

No	Name	Qualification (Level)	Field of Study	Organization/ Institution	Mobile number	E-mail
1	Andualem Abebayehu	MSc	Hydraulics and Water Resource Engineering	Debark PTC	0982095105	andualemabebayhu@gmail.com
2	Mesfin Wondimu	BSc	Construction Technology and Management	Aleta Wondo PTC	0916981613	mesfinwondimu@gmail.com
3	Girema Moges	BSc	Civil Engineering	Wolayita PTC	0911530068	girmamoges@gmail.com
4	Dagim Fekadu	MSc	Construction Technology and Management	Ambo PTC	0910140914	dag.astu.2005@gmail.com
5	Solomon Tadesse	BSc	Construction Technology and Management	GWPTC	0921414347	soletadss@gmail.com
6	Esmael Mohammed	BSc	Water Work construction technology	Kombolcha PTC	0915543225	Bad9565@gmail.com
7	Desalegn Alemu	BSc	Construction Technology and Management	Woliso PTC	0926771683	desalgnalen@gmail.com
8	Tesfaye Assegidew	MSc	Construction Technology and Management	Butajira PTC	0913442444	tesfayeassegidew@gmail.com
9	Mulualem Misganaw	BSc	PLSC	MOLS	0910463950	mulu9192@gmail.com
10	Bacha Kitesa	MPH, MA	Environmental Health since, public health, Project Management	PSI	0910757797	bachakitesa@gmail.com
11	Mesfin Habtemariam	MA, BSc	Civil Engineering, Project Management	PSI	0911124992	mesfinhabtemariam@gmail.com
12	Fisum G/ Egizeebiher	MPH	Environmental Health Science	PSI	0913222354	fegziabher@psiet.org
13	Ziyade Ahmed	MPH	Environmental Health Science	MOH	0916586603	
14	Wondayehu Wube	BSc, MPH	Environmental Health Science	MOH	0972651005	wondayehuwube@gmail.com



የሥራና ክህሎት ሚኒስቴር
Ministry of Labor and Skills