

Manufacturing Sanitation Product and Latrine Construction

Basic Short Term Training

Based on May 2023, curriculum Version- I



Module Title: Carryout Reinforced Concrete work.

Module code: EIS SCW1 04 322

Nominal duration: 32Hours

Prepared by: Ministry of labor and skill.

May, 2023

Adis Ababa, Ethiopia

Table of Contents

Acknowledgment	4
Introduction to the Module	5
Unit One: - Safety in Construction	6
1.1. Construction Health and Safety.....	7
1.2. Construction hazards and control measures	9
Unit Two: Construction Tools, Equipment and Materials.....	11
2.1. Uses of construction tools and equipment.....	12
2.2. Basic Construction Raw Materials	16
Unit Three: Erect and Dismantle Formwork and Scaffolding	21
3.1. Concept of Formwork and Scaffolding	22
3.1.1. Concept of formwork.....	22
3.1.2. Erecting Formwork	24
Unit Four: Rebar and Bamboo Reinforcement	31
4.1. Cutting, Bending, and Fixing Rebar	32
4.2. Cut and Fix Bamboo	34
Unit Five: Carryout Reinforced Concrete Work.....	39
5.1. Mix ratio and batching.	40
5.2. Mix concrete ingredients.....	42
5.3. Transportation and placing.....	43
5.4. Compaction of Concrete.....	45
5.5. Installing different latrine floor improvement plastic technology	46
Installation Sato flex on precast concrete slab.....	53
5.6. Curing of concrete	58

5.7. Concrete material and rebar estimation.....	59
Calculate quantity of rebar	61
5.8. Labor and cost calculation.....	62
Reference	68
Participants of This Module (Training Material) Preparation	69

Acknowledgment

The Ministry of Labor and skill would like to extend its gratitude to MoH, One WASH national Program USAID, PSI, Regional Labor, and skill/training Bureaus, TVT College Deans, Instructors, and industry experts for their financial and technical support of Manufacturing Sanitation Product and Latrine Construction training module. Finally, MOLS extends its gratitude to the following instructors and experts who contributed to the development of this TTLM until its finalization.

Mulualem Misganaw	Senior Expert /TVT Sector	MOLS
Mesfin Habtemariam (MSc)	Engineering Technical Manager	PSI/TWASH
Bacha Kitesa (MpH, MA)	WASH Capacity Development Manager	PSI/TWASH
Fisum G/Egizeebiher (BSc)	WASH Business Development Manager	PSI/TWASH
Dagim Demirew	Associate Director, WASH Business development	PSI/TWASH
Ziyad Ahmed (MpH)	Senior Expert	MOH
Wondayehu Wube (MpH)	Senior Expert	MOH
Andualem Abebayhu (MSC)	Instructor	Debarq PTC
Mesfin Wondimu (BSC)	Instructor	Aleta Wondo PTC
Girema Moges (BSc)	Instructor	Wolayita PTC
Dagim Fekadu (MSc)	Instructor	Ambo PTC
Solomon Tadese (BSc)	Instructor	GWPTC
Esmael Mohammed (BSc)	Instructor	Kombolcha PTC
Desalegn Alemu (Bsc)	Instructor	Woliso PTC
Tesfaye Assegidew (MSc)	Instructor	Butajira PTC

Introduction to the Module

Concrete is the most crucial part of construction project. Concrete is made by mixing a paste of cement, sand, gravel and water in a predetermined amount. Setting of concrete is achieved due to the exothermic chemical reaction between cement and water. The strength of concrete depends up on the quality of its ingredients, proper handling of its ingredient and workmanship.

This module covers the units:

- Safety in Construction
- Construction Tools, Equipment and Materials
- Erecting and dismantling formwork and scaffolding
- Rebar and Bamboo reinforcement
- Carryout reinforced concrete work.

Learning Objective of the Module (training outcome)

- Identify construction health and safety legislative requirements.
- Explain use of construction tools and equipment.
- Erect and dismantle formwork and scaffolding
- Install Rebar and bamboo reinforcement.
- Carry out concrete work.

Module Instruction

For effective use these modules trainees are expected to follow the following module instruction:

1. Read the information written in each unit.
2. Accomplish the Self-checks at the end of each unit.
3. Perform Operation Sheets provided at the end of units.
4. Do the “LAP test” given at the end of each unit and
5. Read the identified reference book for Examples and exercise.

Unit One: - Safety in Construction

This unit is developed to provide trainees the necessary information regarding the following content coverage and topics:(Sub contents under the unit)

- 1.1 Construction Health and Safety
- 1.2 Construction hazards and control measures

This unit will also assist trainees to attain the learning outcomes stated below. Specifically, upon completion of this learning guide, trainees will be able to:

- Identify construction health and safety.
- Identify construction hazards and control measures.

1.1. Construction Health and Safety

Ethiopian Building Code Standards (EBCS 14) Health and Safety in Building Construction

- The goal is to foster a safe and healthy work environment.
- There is wide array of workplace hazards present risks to the health and safety of people at work.
- Personal protective equipment can help protect against many of the hazards.
- These refer to protective clothing, helmets, goggles, respirators etc.
- Any person working on pit excavation, construction, operation, and maintenance of the latrine may be exposed to work related accidents and result in acute injurious health problems, chronic illness, temporary or permanent disability including loss of body parts or death.
- Therefore, it is important to take special precautions during different phases of construction works including during site clearing, pit excavation, lining, construction and installation of latrine slabs, construction and finishing works and during routine operation and maintenances.

The following pictures shows common personal protective equipments used in construction.



Fig1. Personal protective equipment

If Employers of a doing construction, concrete slab and existing latrine toilets work should be required to provide equipment and facilities enabling first aid to be render to their employer when they are injured or become ill at work

First aid box have the following minimum contents: -

- Plasters.
- Bandages.
- Ointments.
- Disinfectant.

It needs to be accesible easily and at least one trained person with needs to be assigned to handle emergency treatments.

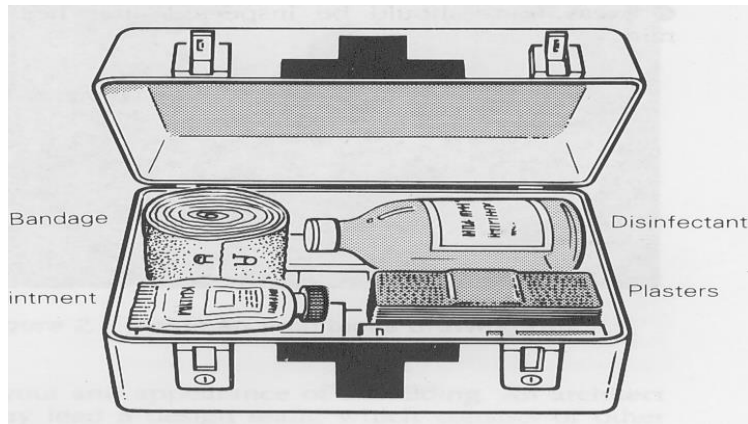

Fig 2. Firs Aid Box

1.2. Construction hazards and control measures

Hazard: means inherent potential of any machine, material, or ambient factors to cause illness or injury from contact with or exposure to construction work something with the potential to cause harm.

In general construction hazard are stated as follows:

Environmental hazards: means a state of danger to human beings or the Environment whether imminent or otherwise resulting from the location, storage or handling of any substance having toxic, corrosive, flammable, explosive, infectious or otherwise dangerous characteristics

Physical hazards

These hazards involve agents in the work environment such as radiation electricity, extreme temperatures, and noise that can cause tissue damage.



Chemical hazards

These are various chemical substances that are toxic or irritating to the body system, including medications, solvents, and gases.



Standard control measures

When considering what control measures are required the following steps can be used in ranking order:

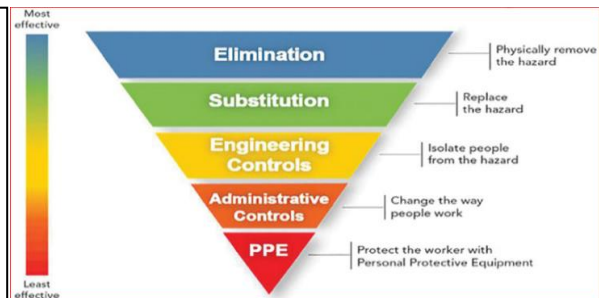

Self-Check 1

Part-I: Choose the correct answer (2pts each)

1. One of the following is not PPE.

- A. Helmet
- B. Gogle
- C. Glove
- D. Sandals

2. Which standard controlling measures are required in the construction sitehazard?

- A. Elimination
- B. Engineering controls
- C. Substitution
- D. All

Part-II: Answer the following questions (2pts each)

1. Which type of hazard involve agents in the work environment such as radiation electricity, extreme temperatures, and noise that can cause tissue damage?
2. Discribe when and where to use PPE.
3. State at least four contents of first aid box.

Note: Satisfactory rating –75% points and above Unsatisfactory - below 75% points

You can ask you teacher for the copy of the correct answers.

Unit Two: Construction Tools, Equipment and Materials

This unit is developed to provide trainees the necessary information regarding the following content coverage and topics: (Sub contents under the unit)

- 2.1. Uses of construction tools and equipment.
- 2.2. Basic construction raw materials





This unit will also assist trainees to attain the learning outcomes stated in below. Specifically, upon completion of this learning guide, trainees will be able to









- Explain use of construction tools and equipment.
- List basic construction raw materials









2.1. Uses of construction tools and equipment

The following tools and equipment are the most type used in bar bending and cutting activities.

Table .1 tools and equipment

Name of tools	Use of tools	Pictures of tools
Manson squire	Used to check to get right angle	
Meter	Used to take measurement	
Plumb-bob	Used to check only that surface vertical leveling.	
Masonry hammer	Used to dress stones in the quarry.	
Chisel	Used to dress hard stone, concrete etc.	

String	Use to make layout in excavation and maintain alignments.	
Sprit Level	Used to with straight edge for getting horizontal and vertical surface levelness	
Rubber tube water level	PVC tube filled with water to check horizontal levels of floors and walls etc.	
Trowel	Used for lifting and spreading mortar on the wall. For forming joint and for cutting brick	
Bucket	Used to carry water, mortar, concrete from one place to another place transporting in the construction site.	
Float	Made for metal, wood, sponge, plastic it used to have smooth mortar or concrete finish.	
Claw hammer	Used to puling/driving and pushing nails.	
Bow saw	Used to cutting wood and timber	

Bar cutter	For cutting soft, medium, and hard metal/reinforcement	
Bar bender	Used for bending reinforcement bar	
Hack saw	Used for cutting reinforcement bar.	
Crowbar	Used for pulling out nails and dismantle wooden materials	
Spade	It used to mix concrete and spreading excavation soil.	
Strike off board	It gives as true smooth concrete surface. It usually requires two workers	
Tamper/compaction other	Used to compact concrete manually system	
Batching box	Used for volume batch of concrete materials standard size of the box 50x40x20cm,	

Pliers	Used to tie transverse reinforcement bars with help of tying wire	
Mixer	It used to mix the concrete can produce 250 liter and up to 6000 liters	
Vibrator	To compact the fresh concrete in the for work. I.e., Footing, columns, beams, slab, stair	
Wheelbarrow	Used to dispose disposal materials from transport or serve materials and tools in the construction.	SSSS 

2.2. Basic Construction Raw Materials

Cement: - Cements are used as binding materials and gives strength to the concrete.

Cement (commonly found in the local market)

Ordinary Portland Cement (OPC)

OPC is hydraulic binding materials producing by intimate grinding of high quality. The disadvantage of ordinary Portland cement is it can not be used for mass concreting as it has high heat of hydration as compared to PPC.

Portland Pozzolana Cement (PPC)

PPC are mixtures of Portland cement and pozzolanic materials that may be either natural or artificial.

- Cement Bags shall be stored in weatherproof sheds with raised floors minimum 25 cm and there should be enough /20 cm gaps between the wall and the piled cement.
- Stocked not more than 14 rows upward and the first stored cement should out first.



Fig-6: Cement brand and store

Aggregates (Sand & Coarse aggregate)

Aggregates are the filler materials, which make up a large portion (roughly 70-75%) of the concrete volume. Care should be taken to provide the best aggregates available.

Coarse aggregates generally shall be basaltic stone gravel. If not, Aggregates should not be produced from decomposed stone and limestone like trachytic stone. In case it is difficult to get crushed aggregates from the vicinity of the site, crushing the stone manually is the solution.

Page 16 of 65	Ministry of Labor and Skills Author/Copyright	Carry out reinforced concrete work	Version -1
			May, 2023

Moreover, stone for aggregate production should be selected first instead of using all available stone around the compound.

- Aggregates shall be clean, hard, strong, durable and sharp.
- Aggregates shall be free from excessive dust.
- Flaky or elongated particles in such form as to affect adversely the strength or durability.



Fig-7: Aggregate

Reinforcement/Rebar

- Rebar's can have different sizes ($\emptyset 6$, $\emptyset 8$, $\emptyset 10$, $\emptyset 12$, $\emptyset 14$, $\emptyset 16$, $\emptyset 20$, $\emptyset 24$ & $\emptyset 32$) and can have different grades, G40, G60, G75 etc. They can also be deformed or flat.
- Care must be taken in using used rebar's.



Fig-8: Rebar standard Size

Bamboo

For bamboo to use as reinforcement, use only bamboo showing a pronounced brown color. This will insure that the plant is at least three years old. Do not use whole culms of green, unseasoned bamboo.



Fig-9: Green and brown bamboo

Hollow Concrete Block

- Concrete Blocks can be Hollow or Solid and may have different sizes (40x20x20, 40x20x15, 40x20x10) and different class, Class A, Class B and Class C.
- Considering availability of testing laboratories & nature of our work, it is not practically feasible to conduct the compressive test for latrine constructions. Therefore, to ensure the quality of the HCB conducting drop test and inspect visually the texture, size, presence of cracks and the ingredients of the block.
- Blocks shall be uniform in texture, shape, size and free from any cracks or defects.



Fig-10: Hollow and solid concrete block

Water

- Water serves two purposes in making concrete. First of all, it triggers the hydration of cement and secondly, it makes the mix fluid and workable. Clean water is important for the same reasons as is clean aggregate; any impurities present will affect bond strength.
- Almost any water that is drinkable, may be used to make concrete. Drinking water with a noticeable taste or odor should not be used until it is tasted for organic impurities.
- Although water is an essential ingredient, too much water added during mixing results in a weak concrete. Very little water is necessary to cause the hydration process.

Therefore, as a general rule, no more water should be added than necessary to make the mix workable.



Fig. 11 water

Formwork (mold): -

Formwork can be made from steel or timber. Timber forms shall be sound and well-seasoned. Needs to have smooth surface at both faces, free from splitting and excessive knots. Steel formwork is durable and best when the shape of concrete is difficult to be done in timber and repetitive use is mandatory. In all types of formworks, it should be in a good condition, free from warping and damages. They should be strong and straight.



Fig-12: Form work to cast slabs and column

Self-Check 1

Part-I: Choose the correct answer (2pts each)

1. Which material account large portion (roughly 70-75%) of the concrete volume
 - a) Cement
 - b) Sand
 - c) Aggregate
 - d) B&C
2. The filler materials in concrete is
 - a) Sand
 - b) Cement
 - c) Form work
 - d) Rebar
3. Used as binding materials and gives strength to the concrete
 - a) Cements
 - b) Sand
 - c) Form work
 - d) All
4. Used to dispose disposal materials.
 - a) Meter
 - b) Wheelbarrow
 - c) Hammer
 - d) Saw
5. Used to measure volume of aggregate and sand.
 - a) Weight balance
 - b) Box
 - c) Mixer
 - d) Pliers

Part II write short answers (2pts)

1. List basic construction materials used in construction of latrines.
2. Write use of mixer
3. Write equipment used in construction.

Note: Satisfactory rating – 75%points and above Unsatisfactory - below 75% points

You can ask you teacher for the copy of the correct answers.

Unit Three: Erect and Dismantle Formwork and Scaffolding

This unit to provide trainees the necessary information regarding the following content coverage.

and topics:

- 1.1. Concept of formwork and scaffolding
- 1.2. Erecting formwork and scaffolding
- 1.3. Dismantling formwork and scaffolding

This guide will also assist trainees to attain the learning outcomes stated in below. Specifically, upon completion of this learning guide, trainees will be able to:

- Explain concept of formwork and scaffolding
- Erect formwork and scaffolding
- Dismantle scaffolding and scaffolding

3.1. Concept of Formwork and Scaffolding

3.1.1. Concept of formwork

Formwork is a temporary support to pre-cast or in situ concrete structure. These temporary supports can be made from timber and steel. It is used to holds the concrete until it sets and can stand on its own till it gains sufficient strength and maintains the required shape.

Types of form work materials

a) Timber/Wood formwork.

Wood or timber formwork is the most common material used for formwork.

Advantage of wood /timber formwork

- It is adaptable.
- It is relatively cheap formwork panels.
- It is more economical than steel where work is non-repetitive work.
- It can be found locally.

Disadvantage of wood formwork

- It is susceptible to insect and fungi attack.
- It warps, Swell and shrink especially when it is not well seasoned.
- It is not economical for repetitive work.

Quality of wooden form work

A good formwork should satisfy the following requirements.

- It should be waterproof when used.
- It should be strong enough to withstand all loads.
- It should be stiff enough so that deflection is minimum.
- It should be as light as possible.
- The surface of the formwork should be smooth, etc.



Fig. 13: Wooden form work to cast concrete slab

b) Steel form work /Panels/ Molds

These forms are made of steel sheets. The selection of these different sizes of steel panels is determined by the SPECIFIC required concrete structure.

Advantages of steel formwork

- Assembled in short time.
- Reliable
- Desired to be reused for several times.
- Gives uniform concrete surface/shape /
- Easy to dismantle.

Disadvantages of steel form work

- The initial cost of steel is very high.
- Attack by corrosion
- Need seasonal anti rust paint.
- Heavy weight



Fig.14: Steel form work/ mold

3.1.2. Erecting Formwork

Procedures of erecting formwork

There are various types of forms used for column, footings, beam, slab, depending upon the size, shape and nature of construction required. The general steps to follow are:

- Prepare form work.
- Measure and mark according to drawing specification
- Cut as per given dimension (e.g 1.2m x 1.2m) when timber is used.
- Fix by confirming the shape and dimension.
- Paint the internal surface of the form work with oil.

Procedure of dismantling formwork

Before dismantling the formwork, wait the concrete to set, harden and gain enough strength to support itself.

- The first thing to care for safety.
- Start the process from the top of the formwork.
- Remove the stakes.
- Remove the sides.

The standard stripping time of formwork (Mold) are stated below.

- | | |
|--|----------------|
| a) Sanitation Concrete mold (depends on mix and weather) | 30min to 1hrs. |
| b) For non load bearing parts of formwork | |
| c) Vertical formworks of beams, columns, and walls | 18 hrs. |
| d) For soffit formwork to slabs | 7 days. |
| e) For props to slabs | 14 days. |
| f) For soffit formwork to beams | 14 days. |
| g) For props to beams | 14 days |
| | 21 days. |

Self-Check 1

Part-I: Choose the correct answer (2pts each)

1. What is disadvantage of steel form work (mold)
 - A. High cost
 - B. heavy weight
 - C. corroded
 - D. All

2. used to shape fresh concrete.
 - A. Form work
 - B. scaffolding
 - C. Mold
 - D. A& C

3. Striping time of column formwork
 - A. 2hrs
 - B. 24 hrs
 - C. 7hrs
 - D, 3hrs

4. The recommended height to starting erection of scaffolding during construction work?
 - A. Under 2m
 - B. above 2.8m
 - C. under 1.7m
 - D. above 1.5m

Part-II: Answer the following questions accordingly (2pts each)

1. List down the types of material used for form work.
2. Write types of material used for scaffolding.
3. Write dismantling time for sanitation latrine concrete slab mold.
4. What are the advantages and disadvantages between steel and wooden form work?

Note: Satisfactory rating –75% points and above Unsatisfactory - below 75% points
You can ask you teacher for the copy of the correct answers.

Operation sheet-3.1: Erect form work

Operation Title: Erecting form work for latrine concrete slab

Purpose: To know the erection of form work to cast 5cm thick, 1.2m square three-piece concrete slab (for sanitation) as per required quality and strength.

Equipment Tools and Materials:

- Meter
- Wooden Form Work
- Try Square.
- Bow Saw.
- Burn Oil.
- Hammer
- Brush
- Nail
- Sprit Level

Steps in doing the task.

1. Prepare wooden form work.
2. Measure and mark according to drawing specification
3. Cut as per given dimension.
4. Fix using nail by confirming the shape and dimension.
5. Paint the internal surface of form work with oil.



Quality Criteria: Assured performing of all the activities according to the procedures.

Precautions:

- ✓ Wearing proper PPES
- ✓ Make working area free hazard.
- ✓ Read and interpret manual which guide you how to use tools and equipment.

N.B.: The steps for erecting formworks may vary as per specific type of works.

Lap Tests

Instructions: Given necessary drawing, tools, and materials, you are required to perform the following tasks accordingly.

Task 1: Select, measure, and cut wooden form work

Task 2: Fix form work as per drawing

Unit Four: Rebar and Bamboo Reinforcement

This unit to provide trainees the necessary information regarding the following content coverage and topics:

- 4.1 Cutting, bending, and fixing rebar
- 4.2 Cutting and fixing bamboo

This guide will also assist trainees to attain the learning outcomes stated in below. Specifically, upon completion of this learning guide, trainees will be able to:

- Carryout cut, bend and fix rebar.
- Carryout cut and fix bamboo.

4.1. Cutting, Bending, and Fixing Rebar

Cutting of rebar

Cut the rebar as per drawing.



Fig-7: Cutting of rebar.

Bending of reinforcement

Bending can be done manually using bar bender and hook type bender or using powered bending machine. Attention needs to be given while bending, as it will affect the lengths specified in the drawings.

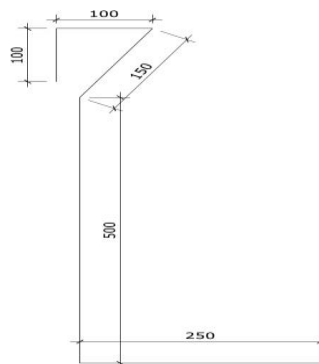
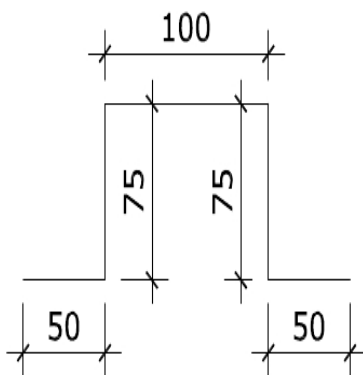

Fig. 18: Bending slab handle and lid rebar handle

Fixing of reinforcement

Tying is normally carried out by using 1 – 1.5 mm diameter black wire.

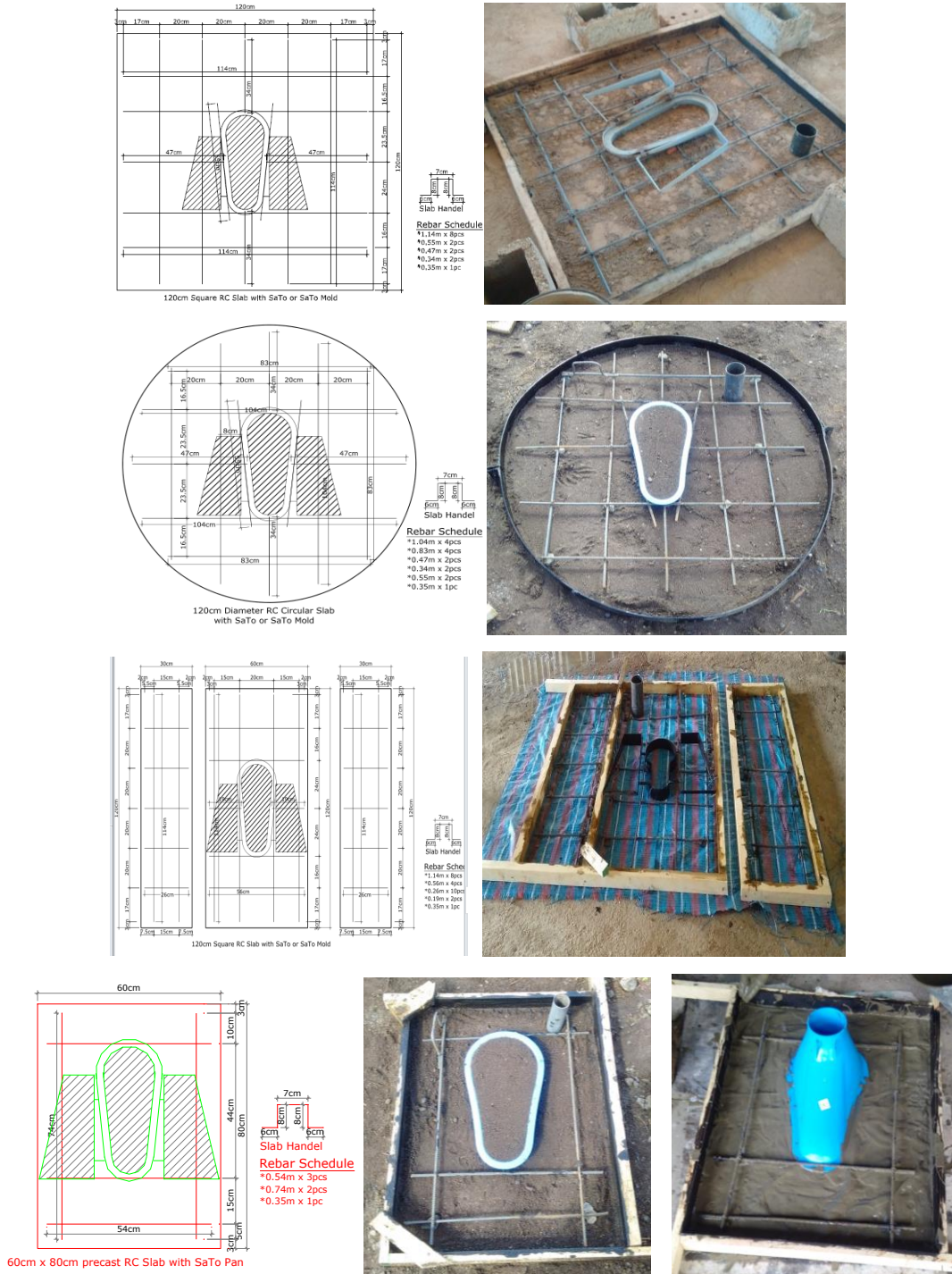
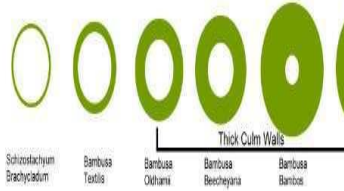













Fig-19: Tie rebar

4.2. Cut and Fix Bamboo

Table 2. Bamboo preparation

Step	Procedure	Picture
Step 1	Select the longest large diameter culms available.	
Step 2	Use only bamboo showing a pronounced brown color. This will insure that the plant is at least three years old.	
Step 2	Store vertically for 2-3 days before its stored horizontally to dry excess waret inside the bamboo could be dried perfectly.	
Step 4	Splitting the bamboo by sharp knife Split bamboo I stronthan full column	
Step 5	Arrange the bamboo mesh before cutting and fix considering center to center, concrete conever	

Step 6	The volume of matting must be 4 times the volume of steel matting and then distance between the bamboo reinforcement can not exceed the reinforcement.		
Step 7	Evenly spaced and lashed together on short sticks placed at right angles to the main reinforcement.		
Step 8	Bamboo should be coated with a thin waterproof coating to reduce swelling then in contact with concrete.		
Step 9	Mix the concrete to 1:2:3 ratio, cement, sand, and gravel respectively. pour the concrete into the mold		
Step 10	Pour the concrete into the mold, then level and compact it using trowels. It is highly recommended to compact the concrete during casting.		

Self-Check 1

Part-I: Choose the correct answer (2pts each)

1. Which one of the following can replace rebar?
A. Wood B. Bamboo C. Form work D. Scaffolding
2. Which Color of bamboo recommended for concrete slab
A. Broun B. Green C. Blue D. Red

Part-II: Answer the following questions accordingly (2pts each)

1. Why bamboo stored vertically.
2. Write recommended diameret of rebar for concreete slab.
3. Why paint bamboo

Note: Satisfactory rating – 75% points and above Unsatisfactory - below 75%points

You can ask you teacher for the copy of the correct answers.

Operation sheet 4.2. Concrete slab with bamboo

Operation Title: Produce bamboo reinforcement for 5cm thick, Ø1.2m circular concrete slab.

Purpose: To know how bamboo is prepared for concrete slab with sato pan

Equipment Tools and Materials:

- Bamboo
- Pliers
- Brush/Sharp knife
- Black Wire
- Formwork oil/used oil/
- Mold
- Meter.

Steps in doing the task.

1. Select brown color bamboo.
2. splitting by sharp knife
3. Measuring and marking
4. place according to Given Dimension
5. tie by black wire
6. Paint oil all surface of the bamboo
7. Place in concrete mold

Quality Criteria: Assured performing of all the activities according to the procedures.

Precautions:

- ✓ Wearing proper clothes, eye glass, glove
- ✓ Make working area hazard free.
- ✓ Read and interpret manual which guide you how to use tools and equipment.

Lap Tests

Instructions: Given necessary templates, tools, and materials you are required to perform the following tasks accordingly.

Task 1: apply measuring, marking, cutting and tie procedure

Task 3: paint oil surface of the bamboo

Unit Five: Carryout Reinforced Concrete Work

This unit to provide trainees the necessary information regarding the following content coverage and topics:

- 5.1. Mix ratio and batching.
- 5.2. Mix concrete ingredients.
- 5.3. Transportation and placing
- 5.4. Compaction and Curing
- 5.5. Installing different latrine floor improvement technology
- 5.6. Concrete material estimation
- 5.7. Material and labourCost calculation

This guide will also assist trainees to attain the learning outcomes stated below. Specifically, upon completion of this learning guide, trainees will be able to:

- Identify mix ratio and batching.
- Perform mix concrete ingredients.
- Describe transportation and placing.
- Explain compaction and curing.
- Install different plastic latrine floor improvement technology.
- Determine concrete material and rebar estimation.
- Determine labor and cost calculation

5.1. Mix ratio and batching.

Mix ratio.

There are two methods of getting proportions of the ingredients of concrete, these methods are

1. Nominal mix.
2. Mix design.

Mix design is used for complex and large construction works. Hence nominal mix is used for latrine construction. The concrete proportions are designed to have an average strength corresponding to the value specified using scientific design methods. The proportions are designed to have an average strength corresponding to the value specified using scientific design methods.

Table-3: Mix ratio

No.	Type of Concrete	Mix Ratio
1	Concrete C – 7 Mechanical mix	1: 4: 8
3	Concrete C – 25 Mechanical mix	1: 2: 3



Fig-20: Mix ratio and batching box

Batching of concrete

Batching is the process of measurement of cement, coarse aggregate, fine aggregate and water for each operation of concrete making. Different consignment of Sand and aggregate are batch separately because they have different ratio during mix and mix of different aggregate .

Method of batching

Batching is done in two ways.

- By Volume (M^3), this is the common ways used in latrine constructions.
- By Weight (KG)



Fig-21: Volumes and weight batching.

5.2. Mix concrete ingredients.

Concrete must be mixed so the cement, water, and aggregates blend into an even mix. Concrete is normally mixed manually and mechanically using mixing machine. The concrete is better mixed with automatic mechanical mixer, but hand mixing is allowed with proper care. Care must be taken:

- To keep the water content to an absolute minimum. Only sufficient water shall be used that will result in workable mix.
- The mix should not be modified by the addition of water, or otherwise to facilitate handling, or for any other purpose.

Advantage of machine mixing is to gain uniform concrete texture, save manpower, high quality mix, minimize wastage etc. Consideration on manual mixing 10% cement for structural elements like footing, column etc. During manual mixing, it should be done on dry and clean area. Machine mixing can be done on site or by a premixed concrete supplier.



Fig-22: Hand and mechanical mix

5.3. Transportation and placing

Transporting of concrete

Concrete may need to be transported from the place of its preparation to the place of its final deposition. Concrete may segregate if not handled carefully during transporting. Care should be taken so that the concrete is not subjected to over vibrations during transit.



Fig. 23: Transporting of concrete.

Placing of concrete

Use of spacers made from the same quality of concrete concrete cover. Bar chain/cobeletto is used to create gap between rebars in double reinforcement fixed on top and bottom.

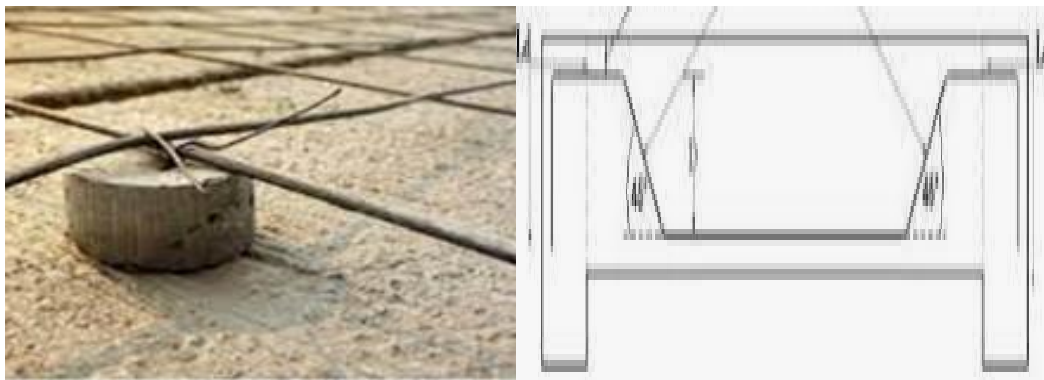

Fig.24: Concrete spacer and bar chain

When placing concrete be careful not to damage or move the formwork and reinforcement. Start placing from the corners of the formwork or, in the case of a sloping site, from the lowest level. Due to the nature of working castingsanitary concrete slabs, agregates can be used as spacers. Spacer thicknesses vary as per drawing but the most common is 1.5cm for slabs and 2.5cm thick for beam and column.



Fig. 25: Placing of concrete.

5.4. Compaction of Concrete

The process of compacting concrete essentially comprises the elimination of entrapped air and achieving maximum density. It needs to be balanced otherwise segregation and bleeding. There are two methods of compaction as:

- Hand compaction
- Mechanical compaction: pendulum Vibrators, compactors, rollers, table vibrators





Fig-26: Hand and mechanical compaction





5.5. Installing different latrine floor improvement plastic technology

Concrete slab with sato pan.

There are different methods of installation to plastic latrine floor improvement technologies to concrete slabs. The following are the common procedure to be followed in each technologies. But all are the same procedure mentioned in this table and if they have different production method we mention in next table.

Table 4. Diameter of 1.2m Concrete slab with sato pan.





Step	M circular Procedure	Picture
Prepare workspace for space	Prepare a working space having an area of at least 3m ² (for each slab to be casted) and level ground. It is preferred if the working space have a shed.	
Dig hole to fit SaTo Pan	Put the mold on leveled surface and join the two half of mold using bolt on mold and tighten it until they fit nicely. Dig the ground with the shape of the SATO Pan by placing it upside down at the center of the ring to give it the same shape. Then, after removing the soil that we have dug, we lift the lid of the SATO Pan and insert it into the hole. We have to make sure that the SATO Pan maintains its level and the floor of the ring is slanted to the SATO Pan. Polish inside surface of the mold with a thin layer of used engine oil, this helps the concrete not to stick to the mold	

<p>Cut reinforcement in size</p>	<p>Prepare 8 mm diameter reinforcement bar and cut to different pieces as follows;</p> <ul style="list-style-type: none"> • pieces of 103 cm • pieces of 83 cm • pieces of 45 cm • pieces of 31 cm • pieces of 60 cm • pieces of 35 cm 	 <p>Each bar to be placed at 3 cm</p>
<p>Mix the Concrete</p>	<p>Mix the concrete in 1:2:3 ratio, cement, sand and gravel respectively. Then mix the three inputs add water until it becomes wet and mix it properly again. 30 liter of water is sufficient to for a bag of cement.</p>	
<p>Cast concrete</p>	<p>Pour the concrete into the mold, then level and compact it using trowels. It is highly recommended to compact the concrete during casting. Smooth the surface of the slab by pouring powder and polish it using clean trowel until it becomes smooth and shiny. The footrest is casted after levelling the oncrete csurface. The footrest can be casted by inverse of sato mold. Wait the concrete for half an hour to dry and remove the drop hole mold gently. Make the surface smooth. Make sure the slope of the slab is toward the drop hole.</p>	
<p>Level and cure</p>	<p>Water the slab to get the required strength. Cure the slab by pouring water three times a day for the first seven days, until it becomes wet uniformly and once per day for the next fourteen days.</p>	

Retrofitting toilet floor with SaTo pan







Retrofit toilet floor with concrete skirting (widehole enough to fit SaTo pan)

Table 5: Retrofit toilet floor.

Step	Procedure	Picture
Step 1	<ul style="list-style-type: none"> Make sure the floor have a sound structure that is well reinforced with wood planks or logs and can support the additional weight. 	
Step 2	<ul style="list-style-type: none"> Make sure the wood planks does not have openings. If there is an opening, use plastic sheet to cover the floor. Put formwork to guide the floor level. 	
Step3	<ul style="list-style-type: none"> If the required concrete fill is high put stones as hard core. Make sure the SATO pan is placed leveled. 	
Step 4	<ul style="list-style-type: none"> Start filling the framework with concrete mix 1:2:3 ratio. The concrete needs to slope toward the drop hole 	
Step5	<ul style="list-style-type: none"> Put the foot pad mold reversed to make footing pad and fill with concrete. Make sure the SATO pan is leveled the closure is working properly by pouring water and pure trow. 	

Retrofit toilet floors with Sato pan/narrow pit hole with Hollow Concret Block



Table-6: -Prefabricated toilet floors with sato pan.

Step	Procedure	Picture
Step1	<ul style="list-style-type: none"> Clean the toilet floor with detergent to avoid smell and clean the floor. when th epit hole is narrow to fix sato pan and difficlut to widen it. 	
Step 2	<ul style="list-style-type: none"> Remove the footing pad if exists. The foot pad is usually a separate structure from the floor not reinforced and can be easily removed. 	
Step3	<ul style="list-style-type: none"> Clean the rough surface and wet the area with water. 	
Step 4	<ul style="list-style-type: none"> Pour the wetted rough area with cement paste for bonding and leveling. 	
Step 5	<ul style="list-style-type: none"> Construct one course concrete block (20 x 40 x 20) arranged as shown jointed with the ratio of 1:3 cement mortar. 	
Step 6	<ul style="list-style-type: none"> Better to use solid concrete block but Hollow concrete block is possible hollow part need to fill with stone and concrete. 	
Step 7	<ul style="list-style-type: none"> Fix the satu an and finish the exposed HCB wall on side and top with smooth plastering. Cure the slab three times a day for the first seven days, until it becomes wet uniformly and once per day for the next fourteen days. 	

Installing of AIM and SATO flex



1. AIM plastic slab is an alternate option to sato pan
2. AIM doesn't need water but needs to move the cover before using





Table-7: Install AIM plastic slab.

Step	Procedure	Picture
1	<ul style="list-style-type: none"> • Check the strength of the latrine wood according to field visit. • Check the edge of the latrine hole gather information from household. 	
2	<ul style="list-style-type: none"> • Lay hard core on the latrine wood and put sato flex/AIM on center of the latrine hole. • Make sure the wood plank does not have openings. If there is an opening, use plastic sheet to cover the floor. Put formwork to guide the floor level. 	
3	<ul style="list-style-type: none"> • Start filling the framework with concrete Mix (1:2:3) ratio • The concrete needs to slope toward the drop hole • AIM slab can be fixed with nail only 	

The following table refers the key points and different procedure to above to cast concrete with SaTo pan with different shape and use of mold.









Table .8 Show us working procedure of different from other.

Name	Description	Pictures
<p>1.2m diameter Concrete slab with Sato pan mold</p>	<ul style="list-style-type: none"> • Prepare 8mm diameter reinforcement bar and cut to different pieces as follows; <ul style="list-style-type: none"> ➤ 104cm =4pcs ➤ 83cm =4pcs ➤ 55cm =2pcs ➤ 47cm=2pcs ➤ 34cm =2pcs ➤ 35cm = 1pc 	
<p>1.2 m square with three pieces with SaTo pan and SaTo mold.</p>	<ul style="list-style-type: none"> • Prepare 8 mm diameter reinforcement bar and cut to different pieces as follows; <ul style="list-style-type: none"> ➤ 114cm =8pcs ➤ 56cm =4pcs ➤ 26cm =10pcs ➤ 19 cm=2pcs ➤ 35cm =1pc • Both left and right concrete slab Size are prepared us 30cm x1.2m. • The size of middle concrete slab is 60cm x1.2m. • The procedure is the same like Table 4. 	

<p>1.2 square with SaTo pan and SaTo mold</p>	<ul style="list-style-type: none"> • Prepare 8 mm diameter reinforcement bar and cut to different pieces as follows; <ul style="list-style-type: none"> ➤ 114cm =8pcs ➤ 55cm =2pcs ➤ 47cm =2pcs ➤ 34cm=2pcs ➤ 35cm =1pc • The procedure is the same like Table 4. 	
<p>60cmx80cm inverted concrete slab with Sato pan.</p>	<ul style="list-style-type: none"> • Prepare 8mm diameter reinforcement bar and cut to different Piece as follows <ul style="list-style-type: none"> ➤ 74cm=2pcs ➤ 54cm=3pcs • Before cast concret use cement screed to gain smooth surface • Foot rest is casted after the concrete dry. 	
<p>60cm x 80cm converted concrete slab.</p>	<ul style="list-style-type: none"> • Re bar quantity is the same with inverted slab • The rest is the same like Table 4. 	
<p>1.2m square, 3pcs improved latrine concrete slab with Sato and Sato mold.</p>	<ul style="list-style-type: none"> • Prepare 8mm diameter reinforcement bar and cut to different pieces as follows; <ul style="list-style-type: none"> ➤ 1.14m= 8pcs ➤ 0.56m=4pcs ➤ 0.26m=10pcs ➤ 0.19m=2pcs ➤ 0.35m=1pc 	

Installation Sato flex on precast concrete slab





Table 9:- Sato flex instalation

Step	Procedure	Picture	Step	Procedure	Picture
1	Check the slab drop hole size if it fits the		5	Put concrete to fix the SaTo	
2	Widen the hole if it is		6	Ensure the slabs slope toward drop hole openings	
3	Remove the footing pads if exists.		7	Level all surface of the slab	
4	Make sure to chisel the slab so that SaTo		8	Finaly finish surface	

NB: Curing are performed after casting by pouring water three times a day for the first seven days, until it becomes wet uniformly and once per day for the next fourteen days.







Retrofitting to existing mud and floor latrine with Sato flex

Table 10: Sato flex on existing mud floor

Step	Procedure	Picture
1	<ul style="list-style-type: none"> • Check the existing latrine floorslab drop hole size if it fits the SaTo Flex. • Check the floor slab drop hole size if it fits the SaTo Flex. • Clean & clear the mud floor and widen the hole if it is small. • Make sure that this doesn't affect the structural integrity of the slab. Otherwise use concret block to raise floor. Remove the footing pads if exists. 	
2	<ul style="list-style-type: none"> • If the required concrete fill is high, put stones as hard core. Make sure the pan is placed leveled. 	
3	<ul style="list-style-type: none"> • Start filling with concrete Mix (1:2:3) ratio. 	
4	<ul style="list-style-type: none"> • Make the surface smooth & ensure the concrete slabs slope is toward drop hole openings. • Cure after casting by pouring water three times a day for the first seven days, until it becomes wet uniformly and once per day for the next fourteen days 	



Retrofitting to existing latrine with concrete floor using Sato flex

Table:11 – Sato flex on existing concrete floor slab

Step	Procedure	Picture	Step	Procedure	Picture
1	Check the existing latrine floor slab drop hole size if it fits the SaTo Flex. Widen the hole if it is small		4	Start filling with concrete Mix (1:2:3) ratio.	
2	Remove the footing pads if exists.		5	Put sato flex on floor	
3	Create rough surface around the pit hole with at least 1-2cm depth. Clean the rough surface and wet the area with		6	Make the surface smooth & ensure the concrete slabs slope is toward drop hole openings.	

Precast concrete with SaTo flex mold

Table: 12- precast concrete with Sato flex

Step	Procedure	Picture
1	<ul style="list-style-type: none"> Place the rebars in the formwork as it is done before in Table 4 & 8. Make sure one rebar is under SaTo Flex footrest 	
2	<ul style="list-style-type: none"> Place the mold and cast with concrete Mix (1:2:3) ratio. 	
3	<ul style="list-style-type: none"> Make the surface smooth & ensure the concrete slabs slope is toward drop hole openings. Cure after casting by pouring water three times a day for the first seven days, until it becomes wet uniformly and once per day for the next fourteen days 	

Precast Concrete ring Production

Concrete rings can be casted in different shape and size. For latrine pit lining, there are three available concrete ring mold sizes are used to cast concrete rings.

- 8cm thick, 50cm height and 1m internal diameter
- 8cm thick, 1m height and 1m internal diameter
- 50cm height and 1.6m internal diameter(this is casted inside the pit hole at required depth and the thickness depends of the gap between the internal ring and pit wall. The minimum thickness of ring for such work is 10cm.

The following are the process taken for casting concrete ring.

The common problems during Sato pan installation.





<p>Improper fixation of Sato pan. The Sato Pan should cover the drop hole properly.</p>	
<p>Slop of slab not toward the drop hole</p>	
<p>Leaving vent pipes open</p>	
<p>Sato pan closure flap not working properly</p>	
<p>Rough concrete surface finish</p>	

Fig-27: Common problems during Sato installation

5.6. Curing of concrete

Curing is the name given to procedures for promoting the hydration of cement. It may be defined as the act of maintaining controlled condition for freshly placed concrete for some definite period following the depositing and finishing operations to assume the proper hydration of cement and proper hardening of concrete.

Advantage of Curing

- Improves wearing quality of the concrete
- Improves the strength of the concrete.
- Improves the impermeability of the concrete depending on the grade of the concrete.
- Improves the durability of the concrete.
- If chemicals are used it shortens the removing time of the form work

Methods of curing

- Shading of concrete work
- Covering concrete surface with wet material
- Continuous sprinkling of exposed surfaces
- Pounding method



Fig. 28- Curing of concrete

5.7. Concrete material and rebar estimation

Calculation of concrete materials

An estimate is probable cost of things, building/slabs/construction. This estimate should not be far away from the actual cost of the building after completion of the project. This unit of measurement can be pieces (No), meter linear, meter square and meter cube.



Fig. 29 circular concrete slab

Circular concrete slab (Diam 120cmx5cm thickness)

VOLUME ($\pi r^2 h$) ~ 0.06 M³

General formula for calculating material list of concrete.

Basic data

Density of cement - - - - 1400 kg/m³

Assume 30% Wastage & Bulkage for Sand and Gravel,
10% wastage & 5% shrinkage for Cement.

$$V = \pi r^2 \times h = 3.14 \times 1.20^2 \times 0.05 \sim 0.06 \underline{\text{m}^3}$$

$$\text{Sum of mix ratio} = 1 + 2 + 3 = \underline{6}$$

Acceptable Answers for concrete ring materials

- a) Cement = $1/6 \times 0.06 \text{ m}^3 \times 1400 \text{ kg/m}^3 \times 1.1 \times 1.05$
= 16.1 kg
- b) Sand = $2/6 \times 0.06 \text{ m}^3 \times 1.3$
= 0.023 m³
- c) Aggregate = $3/6 \times 0.06 \text{ m}^3 \times 1.3$
= 0.035 m³

To change the volume of the Sand & Aggregate by Box

$$\text{BOX} = 50\text{cm} \times 40\text{cm} \times 20\text{cm} = 40,000\text{cm}^3 = 0.04\text{m}^3$$

$$\text{Sand} = \underline{0.023 \text{ m}^3} = 0.023/0.04 \sim \underline{1\text{BOX}}$$

$$\text{Aggregate} = \underline{0.035 \text{ m}^3} = 0.035/0.04 \sim \underline{1\text{BOX}}$$

Calculate quantity of rebar

Steel reinforcement is calculated or measured as per given drawing. Accordingly, total length of iron bar for the below circular slab is:

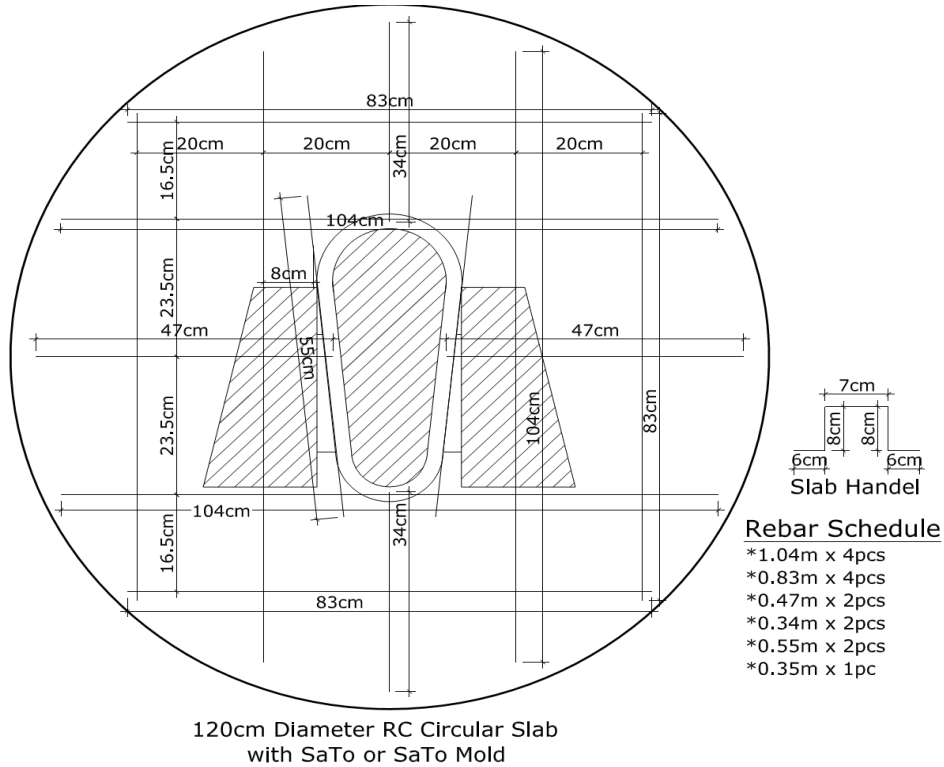

$$1.04m * 4 + 0.83m * 4 + 0.47m * 2 + 0.34m * 2 + 0.55m * 2 + 0.35m * 1 = 10.55m.$$

5.8. Labor and cost calculation

Labor calculation

The number of workers required in the site depends upon the quantity of the work and the time duration for commissioning the project. One most important rule in work control is that shortage of labor must be avoided. The output of labor must be based on the standard working hour and the standard working days, which are usually. Labor cost For Producing circular concrete slab is.

Table -15: labor cost

S/N	Description	Unit	Quantity /Day	Unit price /Birr	Total price/Birr
1	Masons	Pc	6	58	350
2	DL	Pc	6	33	200

Assumption: One mason with one helper can produce 6 slabs per day. The price of labour and the materials needs to be updated as per actual site.

Cost calculation

Summary of quantities required constructing one circular slab above drawing.

Table-16: Cost of materials

S/N	Description	Unit	Batching box	Quantity	Unit price	Total price
1	Cement	kg	--	20		
2	Sand	Box/M ³	1 box	0.03m ³		
3	Gravel	Box/M ³	1.5 box	0.05 m ³		
4	Iron bar ø8mm	m	--	10.55/1berga		
5	Black wire	kg		1/4		
6	PvcØ 75	M		15cm		
7	Formwork oil	Litre		1/6		
8	Sato pan	pcs		1		
9	Water	Litre		60		
	Total					

Self-Check 1

Part-I: Choose the correct answer (2pts each)

1. The unit of measurement for concrete is
 A. M^3 B. M^2 C. KM D. KN
2. _____ is the name given to procedures for promoting the hydration of cement.
 A. Curing B. mix C. bleeding D. cast
3. Probable cost of a building before construction
 A. density B. estimate C. calculation D. none
4. The process of measurement of cement, coarse aggregate, fine aggregate and water for each operation of concrete making
 A. Batching B. curing C. Mixing D. compacting
5. Size of batching box is
 A. 20cmx40cmx50cm B. 30cmx40cmx50cm C. 10cmx20cmx50cm
6. Which is not plastic latrine floor improvement technology?
 A. Sato pan B. AIM slab C. concrete slab D. sato stool.

Part-II: Answer the following questions accordingly (2pts each)

1. List down the types of mix
2. Write density of cement, sand and aggregate
3. List down methods of curing
4. Write advantage of curing
5. Write types of compacting concrete

Note: Satisfactory rating – 75% points and above Unsatisfactory - below 75% points
 You can ask you teacher for the copy of the correct answers.

Operation sheet-5.1: prepare concrete work.

Operation Title: Preparing concrete work.

Purpose: To produce concrete as per required quality and strength.

Conditions or situations for the operations:

- ✓ Safe working area
- ✓ Properly operated tools and equipment
- ✓ Appropriate working cloths fit with the body.

Equipment Tools and Materials:

- | | |
|----------------|-----------------|
| ✓ Trowelcement | ✓ Float |
| ✓ Sand | ✓ Barrel |
| ✓ Aggregate | ✓ Straight Edge |
| ✓ Shovel | |

Steps in doing the task.

1. Wear proper PPE.
2. Clean mix area
3. Select quality raw materials according to mix ration.
4. Batch, mix, transport concrete
5. Cast mixed concrete in mold.
6. Cure concrete for recommended day

Quality Criteria: Assured performing of all the activities according to the procedures.

Precautions:

- Wearing proper clothes, eye glass, glove
- Make working area hazard free.
- Read and interpret manual which guide you how to use tools and equipment.

Lap Tests

Instructions: Given necessary templates, tools, and materials you are required to perform the following tasks accordingly.

Task 1: Perform selection, measure, mix and transport materials

Task 2: perform cast, smooth and curing concrete

Reference

Ethiopian building code standard (EBCS)

MOH manual

A textbook of Building Construction Author: -S.P. Arora

Building Construction Principles & Practices Author :-D.Walton

Participants of This Module (Training Material) Preparation

No	Name	Qualification (Level)	Field of Study	Organization/ Institution	Mobile number	E-mail
1	Andualem Abebayehu	MSc	Hydraulics and Water Resource Engineering	Debark PTC	0982095105	andualemabebayhu@gmail.com
2	Mesfin Wondimu	BSc	Construction Technology and Management	Aleta Wondo PTC	0916981613	mesfinwondimu@gmail.com
3	Girema Moges	BSc	Civil Engineering	Wolayita PTC	0911530068	girmamoges@gmail.com
4	Dagim Fekadu	MSc	Construction Technology and Management	Ambo PTC	0910140914	dag.astu.2005@gmail.com
5	Solomon Tadesse	BSc	Construction Technology and Management	GWPTC	0921414347	soletadss@gmail.com
6	Esmael Mohammed	BSc	Water Work construction technology	Kombolcha PTC	0915543225	Bad9565@gmail.com
7	Desalegn Alemu	BSc	Construction Technology and Management	Woliso PTC	0926771683	desalgnalen@gmail.com
8	Tesfaye Assegidew	MSc	Construction Technology and Management	Butajira PTC	0913442444	tesfayessegidew@gmail.com
9	Mulualem Misganaw	BSc	PLSC	MOLS	0910463950	mulu9192@gmail.com
10	Bacha Kitesa	MPH, MA	Environmental Health since, public health, Project Management	PSI	0910757797	bachakitesa@gmail.com
11	Mesfin Habtemariam	MA, BSc	Civil Engineering	PSI	0911124992	mesfinhabtemariam@gmail.com
12	Fisum G/Egizeebiher	MPH	Environmental Health since	PSI	0913222354	fegziabher@psiet.org
13	Ziyade Ahmed	MPH	Environmental Health since	MOH	0916586603	
14	Wondayehu Wube	BSc, MPH	Environmental Health since	MOH	0972651005	wondayehuwube@gmail.com

